

GROUP GAME

**ROLL
BALL**

OWNER'S MANUAL



Bob's Space Racers Incorporated.

427 15th STREET • DAYTONA BEACH • FLORIDA • 32117

PHONE **386-677-0761** FAX **386-677-0794**

BOBSSPACERACERS.COM

Federal Communications Commission (FCC) Statement

Note: This equipment has been tested and found to comply within the limits for a Class 'A' digital device, pursuant to part 15 of the FCC Rules. These limits designed to provide reasonable protection against harmful interference when the equipment is operated in a commercial environment. This equipment generates, uses, and can radiate frequency energy, and, if not installed and used in accordance with the instruction manual may cause harmful interference to radio communications. Operation of this equipment in a residential area is likely to cause harmful interference in which case the user will be required to correct the interference at his/her own expense.

* * *

W A R N I N G:

ALL OF BOB'S SPACE RACERS® GAMES ARE SHIPPED WITH THE SAME KEY AND LOCK SETS.

IT IS IN YOUR BEST INTEREST TO CHANGE THE KEYS AND LOCKS ON YOUR GAMES WHEN YOU RECEIVE THEM.

SERVICE POLICY

At BOB'S SPACE RACERS[®], INC., our strength lies in the high quality, long lasting equipment we manufacture.

Should the need arise; we maintain both Technical Support and Customer Service staff.

Technical Support is available whenever you should need it. The direct technical 'hot line' is (386) 677-0761. This line is manned 8:30 am - 5:00 pm, EST, Monday through Friday, excluding holidays. During all other times an operator will be available to relay your problem to the technician on call. Technical Support will assist you in troubleshooting a service problem or setting equipment options.

Customer Service telephone lines are manned 8:30 am - 5:00 pm, EST, Monday through Friday, excluding holidays. Customer Service staff can be reached at (386) 677-0761 they will also take parts orders and research the status of previous orders.

As always, you can call (386) 677-0761 to reach all other departments, or you can FAX anyone at BOB'S SPACE RACERS[®] by calling (386) 677-0794, 24 hours a day or e-mailing us at tech@bobsspaceracers.com

BOB'S SPACE RACERS[®], INC.'S ONE-YEAR NEW EQUIPMENT WARRANTY

1. INCLUDED IN THIS WARRANTY Bob's Space Racers[®] Inc. warrants to the original purchaser only that the equipment that is the subject of this sale conforms to its specifications, and is free from defects under normal service for a one-year period from the original date of delivery. This warranty does not include any damages resulting from occurrences listed in Paragraph 2 below. This Warranty is not transferable under any circumstance. Any claims under this warranty must be received in writing by Bob's Space Racers[®] Inc. within 13 months from the date of delivery. Within a reasonable time of such written notification Bob's Space Racers[®], Inc. will replace or repair any defective component of the equipment or part thereof which fails for reasons other than normal services, use, or wear. Light bulbs are specifically excluded from this warranty and shall be the sole responsibility of the purchaser. Bob's Space Racers[®] Inc., within its sole discretion, makes the final determination as to whether to repair or replace any component and whether any such repair or replacement shall be performed where the equipment is located or at its home facility in Volusia County, Florida, or another facility of its sole choice. Any and all freight charges for the purposes of repair or replacement shall be paid by the original purchaser. All defective parts shall be returned to Bob's Space Racers[®] Inc, if requested. Bob's Space Racers[®] Inc, does not warrant that the equipment will meet any original purchaser's specific requirements or that the operation of the equipment will be uninterrupted. These remedies are the original purchaser's exclusive remedies for breach of warranty.

2. EXCLUDED BY THIS WARRANTY. Bob's Space Racers[®] Inc. does not warrant (a) any product, components or parts not manufactured by Bob's Space Racers[®] Inc.; (b) damage caused by use of the equipment for purposes other than those for which it was designed; (c) defects caused by failure to provide a suitable installation environment for the equipment; (d) damage caused by unauthorized attachments, modification, or service; (e) damage caused by normal wear and tear or improper power supply; (f) damage caused by accident or disaster such as fire, flood, lightning and wind; (g) any other abuse or misuse of the equipment.

3. EXCLUSIVE WARRANTY. THE FOREGOING WARRANTY IS EXCLUSIVE AND IN LIEU OF ALL OTHER WARRANTIES OR REMEDIES, WHETHER WRITTEN, ORAL OR IMPLIED. THERE ARE NO WARRANTIES WHICH EXTEND BEYOND THE DESCRIPTION ON THE FACE HEREOF. ANY AND ALL IMPLIED WARRANTIES OF MERCHANTABILITY, FITNESS FOR A PARTICULAR PURPOSE, COURSE OF DEALING OR USAGE OF TRADE ARE HEREBY EXPRESSLY DISCLAIMED AND EXCLUDED.

BOB'S SPACE RACERS® INC.'S ONE-YEAR NEW EQUIPMENT WARRANTY

4. **REMEDIES LIMITED.** UNDER NO CIRCUMSTANCES, EXCEPT TO THE EXTENT PROHIBITED BY APPLICABLE LAW, SHALL BOB'S SPACE RACERS®, INC. BE LIABLE FOR ANY LOSS OR DAMAGE, DIRECT OR INDIRECT, SPECIAL, INCIDENTAL OR CONSEQUENTIAL ARISING OUT OF THE USE OR INABILITY TO USE THIS EQUIPMENT INCLUDING BUT NOT LIMITED TO ANY CLAIM FOR LOSS OR PROFITS, LOSS OF SAVINGS OR REVENUE, LOSS OF USE OF THE EQUIPMENT, OR ANY ASSOCIATED EQUIPMENT, FACILITIES OR SERVICE, DOWNTIME, THE CLAIMS OR COST(S) OF THIRD PARTIES INCLUDING CUSTOMERS, AND INJURY TO PROPERTY.

Some states do not allow limitations on how long an implied warranty lasts or the exclusion or limitation of incidental or consequential damages, so the above limitations or exclusion may not apply to you. This warranty gives you specific legal rights and you may also have other rights which vary from state to state.

5. **NO OTHER WARRANTIES.** Unless modified in writing and signed by both parties, this agreement is understood to be the complete and exclusive agreement between the parties, superseding all prior agreements, oral or written, and all other communications between the parties relating to the subject matter of this agreement. No employee or representative of Bob's Space Racers® Inc. or any other party is authorized to make any other warranty or to assume any other liability in connection with the sale of its equipment.

6. **TIME LIMIT FOR CLAIMS.** Any claim for breach of warranty or claims under this warranty must be received in writing by Bob's Space Racers® Inc. within 13 months following delivery of the equipment.

7. **FUTURE CHANGES.** Bob's Space Racers® Inc. reserves the right to reserve, change or modify the construction and design of its equipment or any component part or parts thereof without incurring the obligations to make such changes or modifications in present equipment.

8. **ALLOCATION OF RISKS.** This agreement allocates the risks of equipment failure between Bob's Space Racers® Inc. and the original purchaser. This allocation is recognized by both parties and is reflected in the price of the goods. **THE PURCHASER ACKNOWLEDGES THAT IT HAS READ THIS AGREEMENT, UNDERSTANDS IT, AND IS BOUND BY ITS TERMS.**

9. **TO OBTAIN WARRANTY SERVICE.** The original purchaser must, at his own expense, bring or ship the equipment to an authorized location for service. Additionally, the original purchaser must pay all freight, shipping or transportation charges for the return of the equipment from Bob's Space Racers® Inc. to the original purchaser. Telephone or write:

Bob's Space Racers® Inc.
427 15th Street
Daytona Beach, Florida 32117
Telephone number 386-677-0761
FAX 386-677-0794

ADVANCED REPLACEMENT POLICY

After speaking with our Technical Department it may be necessary for Bob's Space Racers® Inc. to ship an assembly item or part to repair your game. We will ship the item(s) according to your preference via United Parcel Service, Federal Express, US Postal Service, etceteras. Note: we will not ship anything to P.O. Boxes via the US Postal Service. You will be billed, per your account status, for the total cost of the shipment (which includes shipping charges).

Upon shipment of the new item(s) a Return Merchandise Authorization Number (RMA #) will be issued for you to use when returning the defective item(s) to Bob's Space Racers® Inc. or you may use the order number. After the defective item(s) is received by Bob's Space Racers® Inc. your account will be issued either a:

1. Warranty credit: if your game is under warranty. (See the Warranty Policy page.) Note: This credit does not include return shipping charges.

OR

2. Credit for the item(s). Note: this credit does not include return shipping charges, nor does it include the repair charges for the item(s).

If the item(s) cannot be repaired to the point where it could be shipped to another customer as an Advanced Replacement item (i.e. cosmetic damage), we will ship your original item(s) back to you. You will be required to return the Advanced Replacement item(s) or pay for it. You will be responsible for all shipping charges, should you decide to not keep, and pay for, the Advanced Replacement item(s).

ADVANCED REPLACEMENT ITEM(S) SHIPPING RULES

When you request an Advanced Replacement item from us, we have a few rules for you to follow:

1. **DO NOT** try to repair the defective item(s) on your own; **DO NOT** disassemble the defective item(s) prior to returning it to Bob's Space Racers® Inc. – this could cause further damage and the possibility of you not receiving any credit at all on the item(s). There are not any user serviceable parts inside, and our vendors may void their warranty on disassembled parts. (Please review the last paragraph of the [Advanced Replacement Policy](#)).
2. Wait for the Advanced Replacement item(s) to arrive prior to returning the defective item(s).
3. When the new item(s) arrive, verify that it is the correct part. If it is not, please note what the differences are and contact Bob's Space Racers® Inc.
4. Return the defective item(s) in the exact same packaging the Advanced Replacement item(s) came in. This insures no more damage will be done to the item(s) during the return shipping.

Thank you for your cooperation.

OWNER'S MANUAL

CONGRATULATIONS!

Congratulations on your purchase of a Bob's Space Racers® Game! Bob's Space Racers® continues to lead the amusement industry in the manufacturing and the operation of amusement games and has operated these games at several of North America's largest expositions for the last 30 plus years. Some of these expositions include: The Canadian National Exhibition, Toronto, Ontario, Canada; The Calgary Stampede, Calgary, Alberta, Canada; The Minnesota State Fair, St. Paul, Minnesota, USA; The Ohio State Fair, Columbus, Ohio, USA; The Big E, Springfield, Massachusetts, USA; The South Carolina State Fair, Columbia, South Carolina, USA; and, The Dade County Youth Fair, Miami, Florida, USA. This experience has allowed us the opportunity to field test each piece of equipment that we manufacture, and helps us to stay in tune with the amusement industry with its ever-changing trends.

What you are about to read may appear a little overwhelming at first, but it will help you reach the high profits you seek. Keep in mind we are offering this only as a guide for you to get started. These tips have proved time and again to work successfully in our own operations over the last thirty years.

MANUAL INTRODUCTION

This owner's manual is divided into several sections beginning with Operator's Guide, Introduction and Set-up, and so on. We have provided direction on every aspect of the game from running and maintaining it to pertinent technical information and troubleshooting problems. We, also, cover accounting systems, compressors, lighting, and sound systems in the appendix section.

Each section has troubleshooting guides that contain enough information so that the game can be repaired with little difficulty. If this information is not sufficient, a call to Bob's Space Racers® will provide additional assistance. Between the manual and the personal assistance, downtime of your game will be minimal. (When you call, we assume that you have read this manual and have tried the suggested repairs).

ROLL-A-BALL® TABLE OF CONTENTS

INTRODUCTION

Introduction	1
Getting Started; Why Breaks Are So Important.	2
Getting Ready for Each Day.	3
Game Operations	4
What to Do When It Is Slow; What To Do When It Is Busy	5
What to Give Away; Changing Attendants/Operators.	6

INSTALLATION AND SET-UP

Trailer Set-Up and Hook-Up.	7
Installation of Park and Building Models; Trailer Model Picture.	8
Park and Building Model Pictures	9

OPERATIONS

Game Operation; Push Button Stations.	10
Game Options	11
2400 Electronics Option Register Setting Instructions	12
Roll-A-Ball® Option Register Settings	13

MAINTENANCE

General Maintenance	16
Scheduled Maintenance	17

TECHNICAL DATA

Electronic Module Component Overview; Self-Diagnostics; No Error Features.	18
Automatic Features; CB Off/Reset	18
Push Button Stations and Diagram.	19
Computer Controlled Game Options; Simple Solutions.	20
Electronic Reset Procedures; Activated Switch.	20
Activated Win Switch; Fuse Protection; Bridge Rectifiers; Intermittent and Erratic Problems.	21
Power Supply Diagram	22
Module Electronic Self-Diagnostics.	23
Relay Board Overview and Diagram.	24
Module Relay Board Overview.	25
Module Changes and Updates.	26
Stepper Motor Controller Board Overview.	28
Stepper Motor Controller Board Wiring Diagram.	29
Troubleshooting – 2400 Series Electronics.	30

MISCELLANEOUS

Game Parts List	31
---------------------------	----

*** APPENDIX ***

ACCOUNTING SYSTEM

- 2400 G Module Electronics' Accounting System -1-
- Omni Print OM-200 -4-

SOUND SYSTEMS

- Overview; Amplifiers (A)
- **BSR SOUND UNIT**
 - BSR Sound Unit; Faceplate Diagram (B)
 - Replacing The Music Card; Circuit Board Diagram (C)
 - Switching From Manual Mode to Automatic Mode; Automatic Mode Diagram (D)
 - BSR Multi-Line LCD Diagram (E)

OPERATOR ACCOUNTING SYSTEM (BSR-OAS)

- FCC Regulations -i-
- BSR-OAS Table of Contents -ii-

REMOTE START

- Programming The Remote Start (and Figure 1) (A)
- Replacing The Battery (and Figure 2) (B)

MM-4 FOUR CHANNEL POWERED MIXER

- Specifications -I-
- Introduction; Microphone and Line Inputs; Numbered Diagram -II-
- Channel Level Controls; Clip LED; Master Control; EQ Section -III-
- Effects Loop; Power Amplifier -IV-
- Database History Diagrams -V-

PRO STAR BY TELEX[®] OPERATING MANUAL (UHF WIRELESS MICROPHONE SYSTEM)

- Specifications (A)
- FCC Regulations (B)
- Receiver Set-Up; Diagram; Diversity Light (C)
- Belt Pack Set-Up and Diagram (D)
- Model PH-21 Microphone General Description and Graphic (E)
- Model PH-21 Microphone Specifications and Diagrams (F)
- System Set-Up; Maintenance (G)

REVISED: OCTOBER 2006

INTRODUCTION

INTRODUCTION

The most important thing to remember about the job you are about to begin is to be yourself! Your personality is what keeps you from sounding like a computer. As you are taught the basic procedures, you'll also learn how to adapt them to your own style. Working in the game can be a lot of fun, once you have mastered the proper technique.

ALWAYS REMEMBER THAT THE CUSTOMER IS THE MOST IMPORTANT PART OF THIS BUSINESS!

SMILE! A smile will do more for your business than anything else. It shows the customer that you are happy and they will have some fun.

LOOK PEOPLE IN THE EYE! Making eye contact with people lets them know that you are talking to them, and not just 'rambling on'; A simple, "Hi! How are you?" or, "Hi there! Are y'all having fun today?" will let them know you are talking to them. Follow up with, "Come over here and I'll show you how to play this game!"

USE YOUR FREE HAND to motion the people you're addressing to come over to your game.

ONCE THE CUSTOMER IS AT THE COUNTER, just be polite and explain the game in a simple manner.

WHEN THE GAME IS OVER, be certain to:

1. Acknowledge the winner.
2. Encourage the non-winners to play again, before they start to walk away.
3. Encourage the winner to play again and show him/her the next prize they could trade-up for if they won again.

If you keep these basic procedures in mind, everything else should come together.

GETTING STARTED

No matter what part of the world you may be operating your equipment and, customers are the most important part of making your operation successful. By keeping the customer happy, you will enjoy increased profits. When a customer leaves your game one of two things will have occurred: either you have a satisfied customer who will play that great new game the next time he goes by and will tell his/her friends about it; or, he/she will leave vowing that is the last time that game will ever get his/her money! Of course we all agree that a happy customer is what success is all about.

It is the operator's job to ensure that the customer can easily understand the game and what the prizes are for each win level. This task can only be achieved by the person who will actually be in the game working with the people. There are important features to look for when hiring a game attendant. Always look for a friendly, outgoing personality, someone who is honest, dependable, and is used to working with money. The attendant is the one who will be dealing with the customers on a one-on-one and day-to-day basis.

Although working with the public can be extremely trying at times, by insuring proper breaks for your employees you will eliminate most problems. It is recommended to give the attendant a 30 to 60 minute break every two (2) hours, this way you will always have a fast, outgoing, upbeat attendant running your game. If the attendant is polite and friendly, the public will respond the same way.

WHY BREAKS ARE SO IMPORTANT

Operating a game is physically and mentally demanding. We found it is best to have two (2) attendants for each game, or, three (3) attendants to rotate between two (2) games. This will keep them always at their peak performance and alertness levels. We also suggest you have a part-time employee who can work during the busy/peak times. This person is commonly referred to as the 'second' attendant. It's also important for higher profits. Having two (2) people collecting money can save time and allows the game operation to run much more quickly and efficiently.

GETTING READY FOR EACH DAY

We suggest you begin each day by checking the power. This procedure is done to insure that proper power is being supplied to the game to avoid electrical damage, and/or malfunctions. To check the power coming into your trailer, look for the power checker with a toggle switch on it. This is mounted near the breaker panel. Toggle the switch to the left to test one leg of the power, then right for the other leg of the power. The needle should read approximately 120V AC on each leg.

If either leg does not read 120V AC you will need to locate the supply generator or the city power connections and check the voltage source there. This needs to be done every day because your trailer may have been hooked to a different circuit by a show electrician, from one day to the next, without your knowledge.

If both legs do read 120V AC you can start the game up and check your sound level for both the microphone and the sound track. We find it helpful to label the knobs on the amp so the operator/attendant can easily distinguish between each knob.

It is important to be aware of your merchandise inventory throughout the day, especially during peak times. This will ensure that your game doesn't run out of prizes.

GAME OPERATIONS

Okay, it's time to begin! As each customer passes by they need to be acknowledged with a simple greeting. Such as:

“Hello!”
“Hi, there!”

Followed by:

“How are you?”
“Have you seen this game?”
“Would you like to try it?”
“Are you ready to try this one?”
“Let me show you how to play!”

Remember; make eye contact with the person you are speaking to when you are trying to persuade them to come over to play the game.

Getting the customer to the playing counter is half the battle. Once they are at the counter, quickly give a brief explanation of how to play the game. Then try to get a few more players to begin the race. Note: It's not necessary to have a group of players to begin a skill type game (i.e. Sidewinder®, Roll-A-Ball®, Whac-A-Mole®, etc). However, you do need at least two (2) players to start the game. After you have your desired amount of players, be certain that each player is at the correct player station and you have collected all of the money. Also, know which prize you will be giving out.

Next, go over to the push button station and begin the race. Putting labels on the push buttons during training will make it easier for the training operator to get started. During the race quickly check that all players are playing the game properly, and that they are at their correct play stations. Also, note how many players you have. If possible, note the bystanders and point out any empty positions for them to join in on the next race.

Once the race has ended, announce the winner, encourage non-winners to play again before giving the winner's prize out. Also, get at least one (1) player to pay for the next game before you give the winner his/her prize. For example:

Player at station #5 won and players at #7 and #12 were a very close second and third. You might say, “Hey! #7, you were right there that time! #12 – you should’ve had it! You better try again! This could be your lucky chance! How about another try?” Remember your winner, “Player #5, you were our lucky winner this time! Look at what you’ve won!” At this point you hand him/her the prize and continue by pointing to the next larger prize, “When you win again, you can trade this in for a larger prize!”

GAME OPERATIONS

(CONTINUED)

We've found that by showing the winner the next prize they are easily tempted to play again. Always encourage a few more players with each new race. People are the key to attracting more people to the game.

However, there will be times when only a few customers will be in the playing area.

WHAT TO DO WHEN IT IS SLOW

How fast or slow the operator runs the game is referred to as the 'pace'. Try to get minimum of three (3) or four (4) players before beginning a game. This is commonly referred to as 'grinding'. Simply pay more attention to the players you have already, take more time to explain the rules of the game, explain the prize levels – remember the more people you have at your game the more people will come to your game. It's not uncommon to wait as long as five (5) minutes or more for players. There is no reason to run a race as soon as you have two (2) players, unless there is no one else in the playing area. If the operator runs the races too quickly when it is slow they will end up with no players. If the operator works the crowd as suggested they will find that two (2) players can easily turn into three (3) or four (4), or many more players.

WHAT TO DO WHEN IT IS BUSY

At some point, while grinding, the operator will become 'steady'. This simply means that there are at least five (5) or more players at each and every race. When players are steady, the operator should pick up the pace. The races should be running every three to five (3-5) minutes. If the operator is really good he/she can try to run a race every one to two (1-2) minutes. At the same time the operator should be trying to get at least ten or more players for each race – this would be considered busy.

It is important to make every step count. We recommend the operator go down the counter collecting money from each player while checking to see if there are enough players to begin the race. If there aren't enough players, then quickly make one more sweep up the counter for more before beginning the race. However, if you have enough players there is no need to go all the way back to station #1 to start the race. That is why we have two (2) push button stations in each game.

WHAT TO DO WHEN IT IS BUSY

When the game has ended the operator will follow the same steps as outlined above: acknowledge the winner, encourage the non-winners to play the next race, give the winner his/her prize while showing the trade-up prize if he/she wins the next race, and then get other players to the game. If you find the operator is not able to do all of this in a minute or so, then we suggest having another person in the game to help 'kick-change'. This is a slang term that means basically what it says. Another person is there to kick, or step on the foot pedals to re-set the individual games, and assist in taking money from the players. We normally have our second operator assist a game during peak times.

WHAT TO GIVE AWAY

We found in our operations that 28 to 30 cents on the dollar for give-away has proven the most profitable for us, and the customer. This works out to be 28 to 30 percent of the cost of play. This is achieved by dividing your cost of merchandise by your revenue for that race.

CHANGING ATTENDANTS/OPERATORS

When changing attendants/operators, it is important to do so with as few disruptions as possible. We at BSR have found that this can be done by following a few simple steps.

1. The new operator puts on his/her change apron.
2. The new operator obtains enough one (1) dollar bills from the current/old operator in order to be able to make change for fifty dollars.
3. During a race the old operator hands over the microphone system to the new operator. The new operator continues on with that same race.
4. The old operator checks the amount of stock in the game to ensure there will be enough to last until he/she returns from break.
5. The old operator cleans up any stray trash in or around the game area, and makes certain the game area is orderly.

INSTALLATION AND SET-UP

TRAILER INSTALLATION, SET-UP AND HOOK-UP

Power Requirement: 220V, 60 Cycles, Single Phase

1. Locate trailer and drop Leveler Jacks. Level trailer front to back and right to left. Unwind lead line from hitch. Remove hitch and store out of the way.
2. Unlock awning doors. Raise the doors by use of key switch at the corner of the trailer.
3. Put pins in awning prop rods; release pressure from Hydraulic Pump by turning the key the other direction. Remove key.
4. Hook-up White wire to the Neutral (Common). The Red and Black hook to opposite 110 volt phases. Green is Earth Ground. **NOTE:** Use power checker to check for 110 volts on both hot lines. **CAUTION!** Be sure of correct voltage: 220V, 60 Cycle, Single Phase. **NO MORE!**

GREEN WIRE: Equipment Ground

RED WIRE: 110V AC

WHITE WIRE Common/Neutral

BLACK WIRE 110V AC

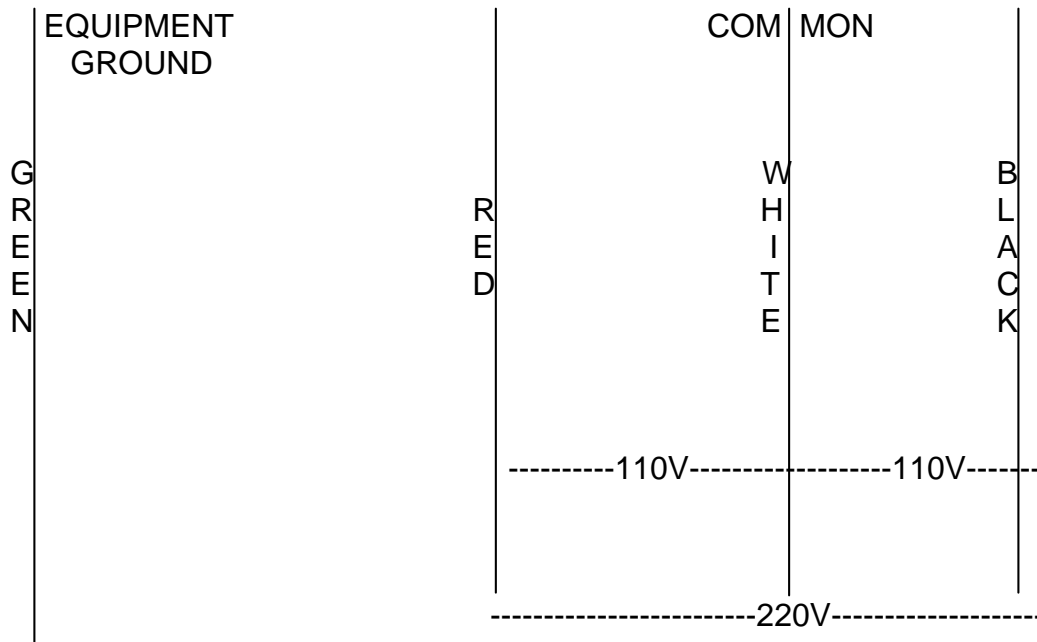

TRAILER INSTALLATION, SET-UP AND HOOK-UP

Power Requirement: 220V, 60 Cycles, Single Phase

5. Raise marquee top and secure with prop rods. Unload ends of marquee from inside game and attach to marquee sides. The ends plug into the sides with a Black Amp plug. Check for bad or broken bulbs. NOTE: Make sure Safety Cables are used when raising the Marquee. Install bally curtains.
6. Check operation of game; check for any bad or broken lights and flash game.

INSTALLATION OF PARK AND BUILDING MODELS

Bob's Space Racers® installs the entire Park and Building Model Games 95% of the time. If you desire to install your game by yourself, we can send separate instructions on how to do so.

ROLL-A-BALL® TRAILER MODEL



ROLL-A-BALL® PARK MODEL



ROLL-A-BALL® BUILDING MODEL



OPERATIONS

GAME OPERATION

1. Collect money.
2. Activate the Player position by kicking the foot switch at the base of the unit. Notice that the small ID Light turns on and stays on.
3. Repeat Steps 1 and 2 for each participant.
4. Repeat entire procedure. (Also see Appendix section, "BSR-OAS".)

PUSH BUTTON STATIONS

1. ON: Pressing the "ON" button will start the game.
2. BELL: Pressing the "BELL" button rings the bell.
2. STOP: Pressing the "STOP" button will stop the game, but the score recorded will not be lost.
4. CB-OFF: Pressing the "CB-OFF" button resets all game scores and deactivates them.
5. PLAIN BUTTON: Starts the Sound Unit.

GAME OPTIONS

Over the years, the game Options for the Roll-A-Ball Group games have increased to ensure the game's continued profitability and excitement. These Options will depend upon which model of electronics and/or Sequencer in the game. First, determine which model of electronics and/or Sequencer is in the game and then refer to the corresponding data sheets. Basically, for pre 1985 games, the only Options available were setting the Winning Score and how fast the heads popped up. Setting the Winning Score was done by setting the Dip Switches on the face of each Control Box (on each unit). The rate at which the heads pop up was done on the Sequencer Unit (determine which model you have and see the corresponding data sheets). For games manufactured between 1985 and 1995, all the Options were set through the Sequencer Unit. These Options consist of setting the Winning Score, Total Game Speed, Progressive and Non-Progressive games. See Sequencer Technical Data sheets (for games made between 1985 and 1995). For games made after 1996, options were set from a LC Display Box (that has a key on it). See Option Registers on following pages for Controls/Options on the game.

2400 ELECTRONICS OPTION REGISTER SETTING INSTRUCTIONS

Enter Options by turning the keyed switch to “on” and waiting until the following message comes up:

“GAME TYPE 001”

This means the system is ready to accept changes for the option registers. The MODE button sequences through each register setting displaying the value in that option register. The UP and DOWN buttons increase or decrease the value of the current register. **The change is NOT made permanent until the ENTER button is pressed.** The ENTER button also advances the screen to the next option register. Pressing the MODE button before pressing ENTER leaves the register unchanged.

NOTE: The Registers CANNOT be changed in the middle of a race and if GAME TYPE is changed, the game MUST be powered down.

MULTI-LINE LIQUID CRYSTAL DISPLAY BOX

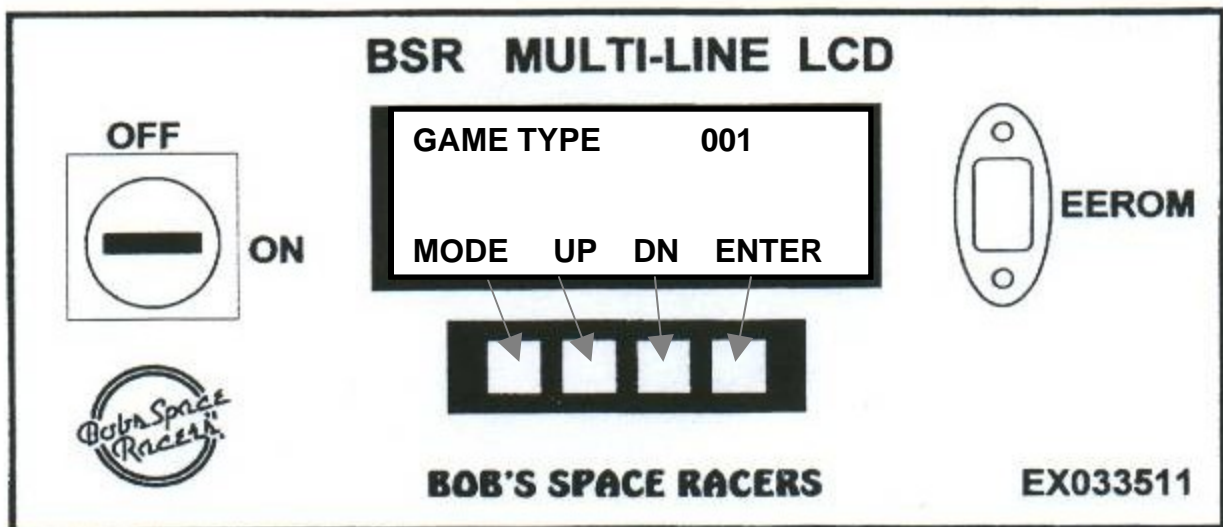

ROLL-A-BALL® 12-FOOT OPTION REGISTER SETTINGS

Option/Game	Roll-A-Ball 12'	Description	Min	Max	Default
<i>Game Type</i>	2	1-Water, 2-RAB, 3-Shifter, 4-Rising, 5-Whac, 6-Driving	1	6	1
<i>Game Mode</i>	0	0-Start @Bottom/Right, 1-Start @Top/Left	0	1	0
<i># Players</i>	#Units	Enter The Number of Units in the Game	2	22	14
<i>Bell Time</i>	20	Time the Bell Rings for in 1/10 seconds	20	40	20
<i>Win Light Time</i>	60	Time the Winner Indicator stays on for in 1/10 seconds	50	100	60
<i>Forward Speed</i>	35	The Fastest Forward Speed for a Motor, the Higher the number, the faster it goes.	10	60	24
<i>Reverse Speed</i>	47	The Speed for a Motor goes Home at, the Higher the number, the faster it goes.	25	50	35
<i>Oper Beacon</i>	60	The Time in seconds until the Operator Beacon turns on out front	0	90	60
<i>Bally Delay</i>	50	The time from the start of one unit to the start of the next unit in 1/10 seconds for Bally Mode	15	100	28
<i>Chase Speed</i>	10	How Many 100ths of a second each Channel of the Chase Lights are on	7	25	10
<i>Short Time 1</i>	28	Walk Time RAB	18	28	28
<i>Med Time 1</i>	34	Trot Time RAB	30	35	34
<i>Long Time 1</i>	34	Run Time RAB	30	35	34
<i>Zone Length</i>	80	Time the Toy moves before using the "2" Timing Values RAB	80	100	95
<i>Short Time 2</i>	12	Walk Time After Zone RAB	10	16	12
<i>Med Time 2</i>	16	Trot Time After Zone RAB	14	16	16
<i>Long Time 2</i>	16	Run Time After Zone RAB	14	16	16
<i>Mole Up Time</i>	53	Time that the Mole Heads Stay Up for in 100ths seconds WAC	48	53	53
<i>Mole Down Time</i>	15	Time between Moles in 100ths Sec WAC	10	15	15
<i>Win Score X 10</i>	0	Score to Win At #x10 WAC	10	15	15
<i>Reverse Time</i>	50	Time From a Win until Toys Back Up	40	100	50
<i>Min Speed</i>	20	Off the Track Speed RACE	1	40	20
<i>Slow Speed</i>	35	Slow Speed RACE	30	50	35
<i>Medium Speed</i>	45	Medium Speed RACE	30	55	45
<i>Fast Offset</i>	30	Width of Run RACE	10	45	30
<i>Med Offset</i>	70	Width of Med Past Run RACE	20	80	70
<i>Slow Offset</i>	120	Width of Slow Past Med RACE	30	120	120
<i>Track Speed</i>	70	Speed Table Spins at on Race Game	50	70	70
<i>Lo Money Val</i>	1	Amount to add per player for Lo Money	1	9	1
<i>Hi Money Val</i>	2	Amount to add per player for Hi Money	0	9	2

ROLL-A-BALL® 12-FOOT OPTION REGISTER SETTINGS

<i>Option/Game</i>	Roll-A-Ball 12'	Description	Min	Max	Default
<i>Auto Start TM</i>	* 1	0 = Man, 1 = Auto, 2 = Intro, & 3 or Greater is Timed	0	255	1
<i>Track Sub Value</i>	8	Value To Subtract From Track Speed	5	12	8

* NOTE : Any Games without DMR Jumper & Update Programs use 0 for Auto Start TM

RELEASE DATE: 06/11/03

ROLL-A-BALL® 15-FOOT OPTION REGISTER SETTINGS

Option/Game	Roll-A-Ball 15'	Description	Min	Max	Default
<i>Game Type</i>	2	1-Water, 2-RAB, 3-Shifter, 4-Rising, 5-Whac, 6-Driving	1	6	1
<i>Game Mode</i>	0	0-Start @Bottom/Right, 1-Start @Top/Left	0	1	0
<i># Players</i>	#Units	Enter The Number of Units in the Game	2	22	14
<i>Bell Time</i>	20	Time the Bell Rings for in 1/10 seconds	20	40	20
<i>Win Light Time</i>	60	Time the Winner Indicator stays on for in 1/10 seconds	50	100	60
<i>Forward Speed</i>	40	The Fastest Forward Speed for a Motor, the Higher the number, the faster it goes.	10	60	24
<i>Reverse Speed</i>	47	The Speed for a Motor goes Home at, the Higher the number, the faster it goes.	25	50	35
<i>Oper Beacon</i>	60	The Time in seconds until the Operator Beacon turns on out front	0	90	60
<i>Bally Delay</i>	50	The time from the start of one unit to the start of the next unit in 1/10 seconds for Bally Mode	15	100	28
<i>Chase Speed</i>	10	How Many 100ths of a second each Channel of the Chase Lights are on	7	25	10
<i>Short Time 1</i>	28	Walk Time RAB	18	28	28
<i>Med Time 1</i>	34	Trot Time RAB	30	35	34
<i>Long Time 1</i>	34	Run Time RAB	30	35	34
<i>Zone Length</i>	95	Time the Toy moves before using the "2" Timing Values RAB	80	100	95
<i>Short Time 2</i>	12	Walk Time After Zone RAB	10	16	12
<i>Med Time 2</i>	16	Trot Time After Zone RAB	14	16	16
<i>Long Time 2</i>	16	Run Time After Zone RAB	14	16	16
<i>Mole Up Time</i>	53	Time that the Mole Heads Stay Up for in 100ths seconds WAC	48	53	53
<i>Mole Down Time</i>	15	Time between Moles in 100ths Sec WAC	10	15	15
<i>Win Score X 10</i>	0	Score to Win At #x10 WAC	10	15	15
<i>Reverse Time</i>	50	Time From a Win until Toys Back Up	40	100	50
<i>Min Speed</i>	20	Off the Track Speed RACE	1	40	20
<i>Slow Speed</i>	35	Slow Speed RACE	30	50	35

ROLL-A-BALL® 15-FOOT OPTION REGISTER SETTINGS

Option/Game	Roll-A-Ball 15'	Description	Min	Max	Default
<i>Medium Speed</i>	45	Medium Speed RACE	30	55	45
<i>Fast Offset</i>	30	Width of Run RACE	10	45	30
<i>Med Offset</i>	70	Width of Med Past Run RACE	20	80	70
<i>Slow Offset</i>	120	Width of Slow Past Med RACE	30	120	120
<i>Track Speed</i>	70	Speed Table Spins at on Race Game	50	70	70
<i>Lo Money Val</i>	1	Amount to add per player for Lo Money	1	9	1
<i>Hi Money Val</i>	2	Amount to add per player for Hi Money	0	9	2
<i>Auto Start TM</i>	* 1	0 = Man, 1 = Auto, 2 = Intro, & 3 or Greater is Timed	0	255	1
<i>Track Sub Value</i>	8	Value To Subtract From Track Speed	5	12	8

* NOTE : Any Games without DMR Jumper & Update Programs use 0 for Auto Start TM

RELEASE DATE: 06/11/03

MAINTENANCE

GENERAL MAINTENANCE INFORMATION

TO CLEAN GAMES:

You may use soapy water on Formica, Plexi-glass, regular glass, Stainless Steel, and other metals without causing any damage. The following list of cleaners can only be used on the materials they are listed with. If a cleaner is used on a material that it is not listed with it will cause damage to that material and Bob's Space Racers® will not be held responsible for repair and/or replacement of that damaged material.

Cleaner

Lacquer Thinner
Mineral Spirits
Clean-On-The-Go Glass

De-Solve-It®
Brilliance™
Windex®
3812S Enamel Reducer
Old English® Oil; Baby Oil

Material

Formica; regular glass
Formica; Plexi-glass; Stainless Steel; other metals
Formica; regular glass; Stainless Steel; other metals
and Hard Surface Cleaner™
Formica; Plexi-glass
Plexi-glass; regular glass
Regular glass
Plexi-glass
Formica; Stainless Steel; other metals

Daily: Check for proper oil level (use SAE-30 non-detergent); drain and condensate from receiver and traps; listen for any unusual noises and check for vibrations.

Weekly: Visually check air filter for debris and dust; clean all external parts of compressor and driver; test safety valve manually to be certain it does not stick.

Monthly: Inspect entire system for leaks; inspect oil for contamination and change if necessary; check belt tension and wear.

Three (3) Months: Make a complete oil change; inspect valve assemblies.

ROLL-A-BALL® SCHEDULED MAINTENANCE

DAILY

1. Visual inspection of game.
2. Check bulbs.
3. Clean all Formica.
4. Check Win Lights. Make sure each unit can win.

WEEKLY

1. Remove counter tops; inspect micro switches and attached wires.
2. Lemon oil all Formica.

TECHNICAL DATA

ELECTRONIC FEATURES

800 SERIES ELECTRONICS

In 1988, **Bob's Space Racers®** began using the BSR800 Board. This Board was a microprocessor based system that allowed for a greater flexibility for future options and ease of troubleshooting and assembly.

800 Microprocessor Board

Inputs

On the Circuit board, there are nine LEDS (little red lights). Each LED corresponds to an Input chip (LED #1 works with Input #1 which is U1). To determine if an Input is working, activate the Input and see if the LED comes on. For example, if it is suspected that a footswitch on a particular unit is bad, look at LED #2 while someone kicks the footswitch. The footswitch is Input #2, so LED #2 should come on while the footswitch is held down.

The Inputs are as follows:

1. Interrupt (not used)
2. Footswitch
3. Stop Button
4. Start Button
5. Win Switch from Track
6. Walk Input (on Pinball™ and Roll-A-Ball™)
7. Trot Input (on Pinball™ and Roll-A-Ball™)
8. Run Input (on Pinball™ and Roll-A-Ball™)
9. Win Line (some other unit won, shut off)

NOTE: Input #7 is the Sensor Input on a Handle game, in which case inputs 6 and 8 are NOT used.

Outputs (U10 – U13)

Outputs U11, U12 and U13 are responsible for two relays each. Each one of these ICs turns on the relays on either side of it at the proper time. U10 is responsible for two the other Outputs. One Output is to the Accounting System to signify that the unit is being played. The other output is to tell all the other circuit boards when it has won.

Dip Switches

There are two sets of Dip Switches: Bank 1 and Bank 2. They are for setting the time for Walk, Trot, and Run. There are four switches used for each setting. Switches 1-4 on Bank 1 are for Walk. Switches 5-8 on Bank 1 are for Trot. Switches 1-4 Bank 2 are for **Walk**, Switches 5-8 on Bank 2 are for **Trot**, Switches 1-4 on Bank 2 are for **Run**, and Switches 5-8 on Bank 2 are not used. To turn a Switch "On" or "Off", look to the far right side of the Bank of Switches. The "On" side and the "Off" side are marked. To turn a Switch Off, push the Switch in the 'Off' side. A red flag will appear on the 'On' side indicating that it is 'Not On'. To turn the Switch On, push in on the 'On side, making the red flag come up on the 'Off' side indicating that it is 'Not Off.'

Set the time for Walk first. Then, set the time for a Trot by selecting the additional time it should be set for, more than a Walk. For example, you want Walk to equal .8 seconds and Trot to equal 1.4 seconds. You would set the Walk for .8 seconds and the Trot to for .6 seconds because .67 seconds is the amount of additional time you want to give to a Trot, or a Trot time would equal the Walk setting plus the Trot setting.

The Run setting is the additional amount of time you want Run to be over that set for Trot, or, Run Time will be the equivalent of the Run Setting plus the Trot setting plus the Walk setting.

NOTE: To set the time on a handle game, set the Trot plus the Walk time for you Total time.

Electrical Outputs

Originally, the 9 pin plug, which is the Outputs on the 800 Board, was connected to AC Hot and AC Neutral for each Output. This included the Ball Stop, the Bell, and the Win Light for that particular unit. When any unit was activated, the Bell would ring. There was one Win Light for each unit that controlled its own Win Light and also, there was Ball Stop Output for each unit. This Ball Stop Output was only used on the Roll-A-Ball™ version of the game.

On later models, i.e., after the first year of manufacturing, the (Outputs were Ground Outputs (DC Outputs) that ran to a solid state relay board that converted all the DC signals into AC. This was used to improve all dangerous potential voltages from down where the circuit boards are located.

The first thing to do in order to troubleshoot the electronics in the game is identify whether you have a solid state relay board or not. The solid state relay board would be located on the backside of the game near the highest numbered player position and just below the Win Light (on the backside of the game) for that player position. It looks like a circuit board with many small, black, rectangular solid state relays screwed to the board.

This information is useful so that we can identify what type of problem you may have so that we may know what types of voltages to be checking for whenever we are trying to identify where a problem is located.

OPTION SWITCHES

BSR800 Board

Each unit of the game has a Control Board. On each Control Board there are two banks of Dip Switches to set your Options. We refer to these Dip Switches a Dip 1 and Dip 2. Each bank of Dip Switches consists of 8 On/Off Switches. These switches are used to set the amount of time that the motor will turn on for when the ball falls through the 'Target Switch (s)'. The total time is calculated by adding three (3) time settings together. The time settings are determined in the following manner:

- Dip 1 Switches 1 through 4 are setting 1
- Dip 1 Switches 5 through 8 are setting 2
- Dip 2 Switches 1 through 4 are setting 3
- Dip 2 Switches 5 through 8 are NOT USED!!!!

The amount of time for each setting is determined by the table below. The total time of a ball hitting run is calculated by adding Setting 1 and Setting 2 and Setting 3. The Setting 3 time can vary between 0.3 second (minimum setting of 0.1 for each setting) up to 4.8 seconds (maximum time of 1.6 second per setting).

Time for Setting 1=off, 0=on

Switch_1	Switch_2	Switch 3	Switch 4_	Total Time
0	0	0	0	0.1
1	0	0	0	0.2
0	1	0	0	0.3
1	1	0	0	0.4
0	0	1	0	0.5
1	0	1	0	0.6
0	1	1	0	0.7
1	1	1	0	0.8
0	0	0	1	0.9
1	0	0	1	1.0
0	1	0	1	1.1
1	1	0	1	1.2
0	0	1	1	1.3
1	0	1	1	1.4
0	1	1	1	1.5
1	1	1	1	1.6

Accounting Board



Phihong Power Supply

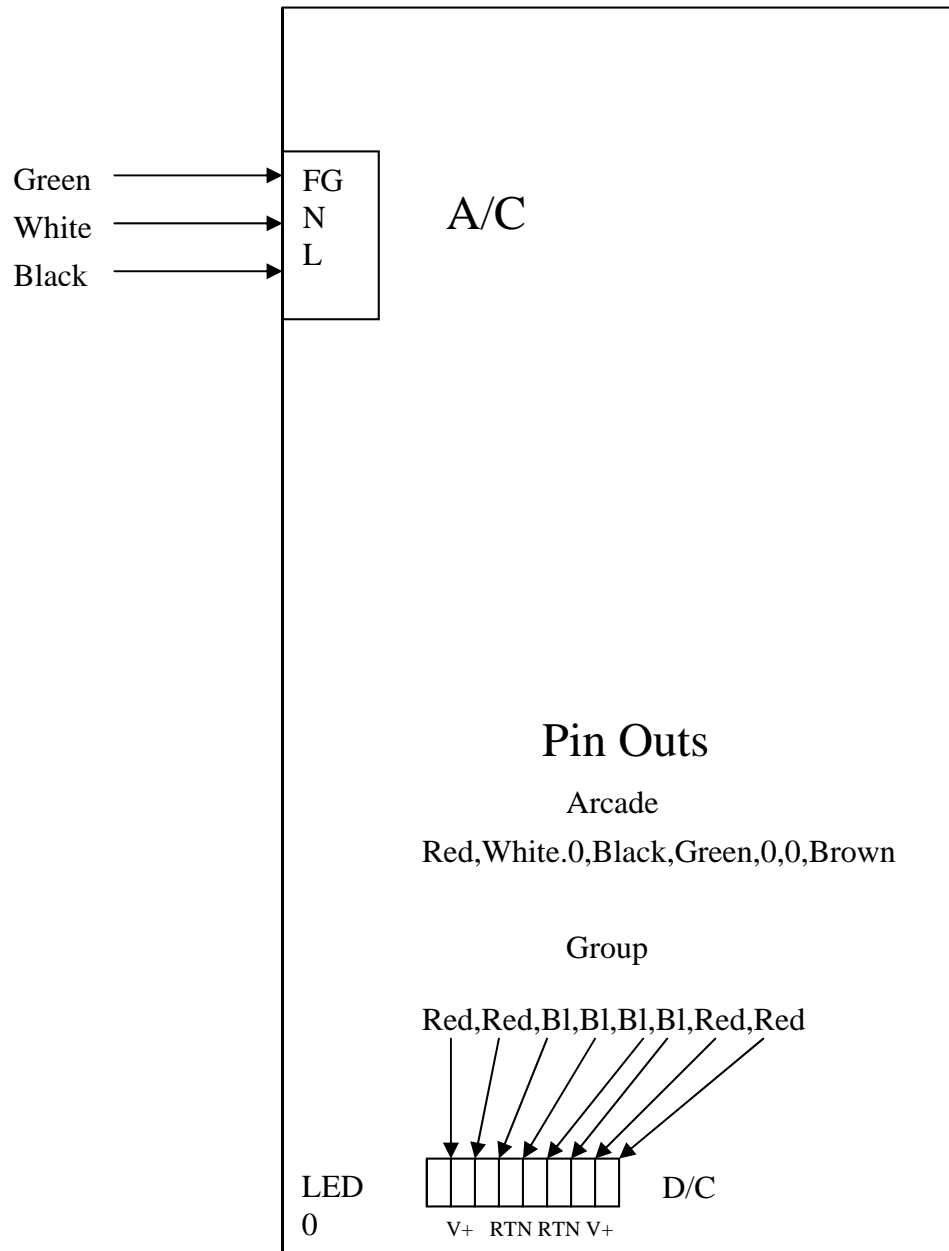

ELECTRONIC MODULE COMPONENT OVERVIEW

Bob's Space Racers® exclusive module electronics are as easy to change and repair as our old style relay systems. Modules pop out and pop in if problems arise, no boards or cables to change. Modules can be swapped between the unit board and the master board. One spare module can repair problems or update your game features. Note: Game Power must be **OFF** before adding or removing components.

SELF-DIAGNOSTICS

2400 Electronics are equipped with easy to use self-diagnostic LED's. These LED's are easily read to sort out most problems that can occur in operation. If problems occur our Technical Services can easily identify problems by noting which of these LED's are on or off.

NO ERROR FEATURES

Nothing is worse in a group game than having switches stick! This causes an unfair advantage for a player or disrupts the entire game. 2400 Electronics will not let the unit turn on or it will turn the unit off, when the game starts.

AUTOMATIC FEATURES

New for 2400 Electronics: 1) the 1-button Autostart; 2) the timed Autostart; and, 3) the manual start features.

1. **Manual Start:** Setting 0 – The operator pushes each start button for sound, game and bell manually at the time sequence desired.
2. **1-Button Autostart:** Setting 1 – This is your 1-button start feature for all sound, game and bell. This is for new and untrained operators. Hit 1 button and everything sequences in proper order to start the game, the same every time.
3. **Timed Autostart:** Set at time desired (This feature is for the serious operations.) “Time is Money” – Set your time desired and get ready - what you set is when we start.

CB OFF/RESET

All 2400 Electronics have “CB Off” or “Reset” button. This button is used to reset the present game. If units were inadvertently turned on, press and hold the “CB Off” button. In about two seconds, the game will reset and be ready for play. This will sometimes cure your odd problems. If “CB Off” doesn't work, simply physically turn off game power at main breaker panel, wait 16 seconds, and turn the game power breaker back on. Just remember “Reset to Repair”.

ROLL-A-BALL & RACERS EDGE 2400 MASTER BOARD

FEMALE PLUG - MALE PINS
PUSH BUTTON STATION - J18 & J19

FEMALE PLUG - MALE PINS
SUPER SHIFTER
XMAS TREE - J8

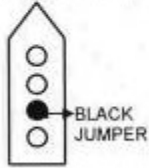

MALE PLUG - MALE PINS
REG + 12V - POWER - J17
18/5

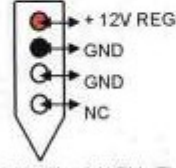

Pins 1 & 2 Not Used At This Time

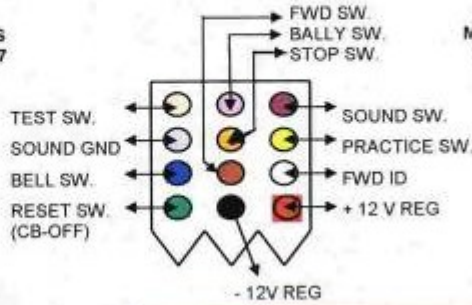

MALE PLUG - FEMALE PINS
HI/LO SWITCH - J21
#23 - 22/2

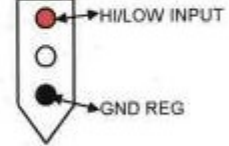

FEMALE PLUG - MALE PINS
REG + 12 V - J22

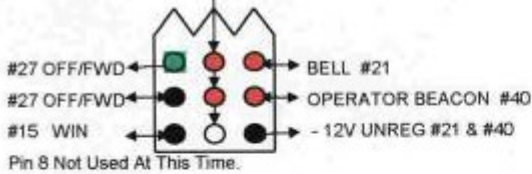

UNREG + 12V - POWER - J23

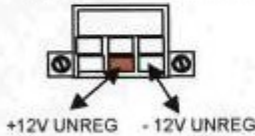

4 CHANNEL CHASE - J24 & J25
RUNNING LIGHTS
22/5 - #36

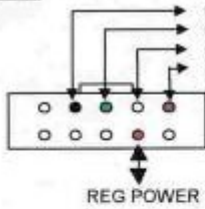

GLOBE FLASHER & WIN LINE
22/5 - #36 & 22/2 #15

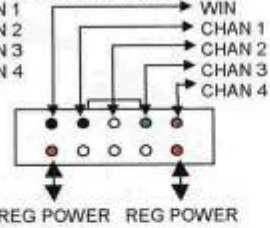

LED SWITCH ARRAY BLOCK

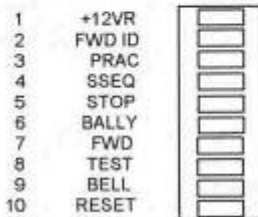

ROLL-A-BALL & RACERS EDGE 2400 UNIT BOARD

REG +12V POWER- J14
MALE PLUG - MALE PINS

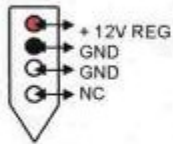

I.D. LIGHTS/FOOTSWITCH - J17
MALE PINS - FEEMALE PLUG
#UNIT 22/8 LIGHS & #0 FOOTSWITCH 22/5

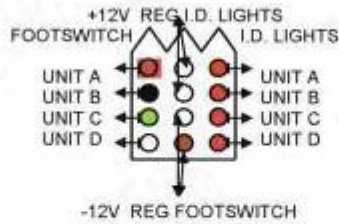

BALL STOP - J18
MALE PINS - FEMALE PLUG
#UNIT - 22/8

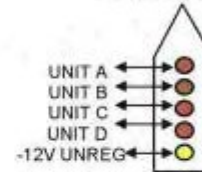

ROLL-A-BALL & RACERS EDGE
RUNNING LIGHTS - J19
MALE PINS - FEMALE PLUG

#15 - 22/2
UNITS

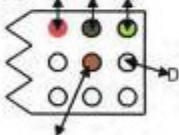

-12V UNREG
Pins 1, 2, 4 & 7 Not Used In With 22/5

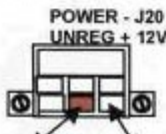

+12V UNREG -12V UNREG

MADU PLUG - J8 - 22/8
UNIT # UNIT

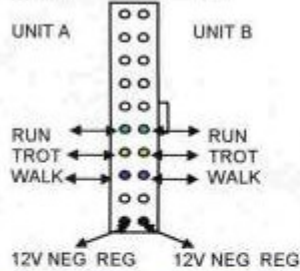

MADU PLUG - J13 - 22/8
UNIT # UNIT

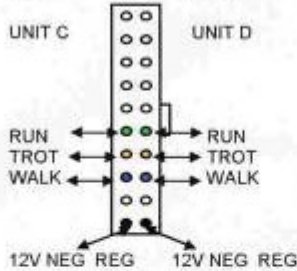

FOR GAMES WITH I-BUTTONS
I.D. LIGHTS/FOOTSWITCH - J17 - 22/5
MALE PINS - FEEMALE PLUG
#18 LIGHS & #0 FOOTSWITCH - #11 I-BUTTONS

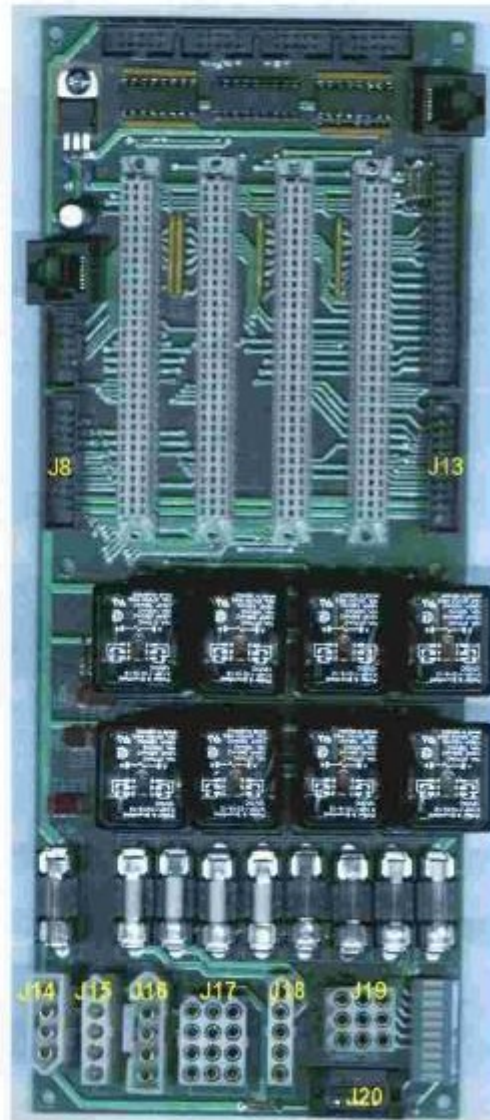
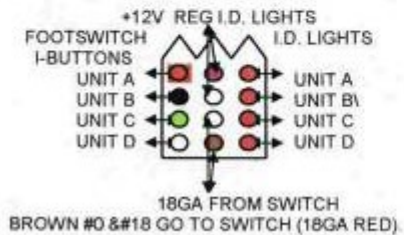

PUSH BUTTON STATIONS

1. **FORWARD:** Pressing the "Forward" button will start the game and turn on the forward I.D. light.
2. **CB OFF:** Pressing the "CB OFF" button will re-set the game and return the toys to the home position.
3. **STOP:** Pressing the "Stop" button will cause the game to pause.
4. **BELL PUSH BUTTON:** Pressing the "Bell" button will ring the bell.
5. **DMR PUSH BUTTON:** Pressing the "DMR" button will activate the Sound Unit.
6. **PRACTICE/DEMO BUTTON:** Some models have a practice button.
7. **BALLY BUTTON:** The bally sequence only lasts two minutes.

NOTE: These are some of the features that you may choose to have on your system, and do not necessarily reflect the total number of buttons or options available for the game.

COMPUTER CONTROLLED GAME OPTIONS

In all 2400 Electronics ALL game features and controls can be set and changed using the keyed BSR MULTI-LINE LCD display panel. The option registers settings are based on years of testing and operating experience and preset by Bob's Space Racers® technicians. These settings can be changed by the end user depending on your operational needs. (See Option Register Setting Instructions beginning on the next page.) If you have any questions about these settings please contact our Technical Services department.

SIMPLE SOLUTIONS

Look for the simple things first, 90% of problems that occur with BSR equipment are simple things that are overlooked.

- Loose wires
- Bad Connections
- Loose modules or relays
- Something has been changed around by someone else's action

Example: someone plugs a wire connector into a wrong plug or someone disconnects something.

ELECTRONIC RESET PROCEDURES

There are 2 ways to reset your game. One is "CB OFF" (Computer Board Off) button and 2nd is game power breaker.

- First try the "CB OFF" button located at each end of the game where start and stop push buttons are.
- Second turn the game power breaker off at the power panel, wait 15 seconds and turn breaker back on. Something to remember - 2400 electronic is a computer, if it gets "lost" it must be reset to start over properly.

ACTIVATED SWITCH

Hung or stuck switches can cause an unfair and revenue losing problem. To cure this, our 2400 Electronics senses this problem before it is too late. If one of the symptoms arise the foot-switch was the problem, the unit simply will not turn on. If you have a footswitch that lights up when turned on, and goes out when footswitch is released, then you must fix the stuck switch before this unit will turn on.

ACTIVATED WIN SWITCH

Hung or stuck win switches can cause confusion, when you push “Forward” button the game or unit automatically wins immediately without reaching the end of the track. To eliminate this problem in 2400 Electronics we simply turn the problem unit off when the game is started. If you have a unit that turns off when a race is started, check the win switch for problems. All other units will continue to operate normally so not to confuse the whole game.

FUSE PROTECTION

Your game has fuses located at/and for the following:

Power supply/bridge rectifier protection; located beside the power supplies in the power supply box (See Power Supply Layout, page 12.) The ID light beside the fuse post represents a fuse in proper working order when lit.

Relay board fuses - mounted on Master Relay and Unit Relay Boards.
Surge protectors - mounted on breaker panels.

There are numerous fuses located throughout each game. Be familiar with the locations of each of these, and check those first when problems arise.

BRIDGE RECTIFIERS

Your game also has bridge rectifiers. If fuses in the power supply box blow immediately when replaced the bridge rectifier for that fuse must be replaced. If your game has a certain number of units not working, i.e.: four in a row or one side of game. The cause would be a blown bridge rectifier and fuse. In this condition both fuse and bridge rectifier will be blown.

INTERMITTENT AND ERRATIC PROBLEMS

If the game is demonstrating erratic behavior that doesn't affect multiple units it's best to power down the game then power the game back up. If the problem continues, recall the symptoms or behaviors and call Bob's Space Racers® Tech Service for help in repairing the problem.

Intermittent problems are the hardest to find and cure. If you have an intermittent problem please keep details on the problem, symptoms and details on when the problem occurs. Note how it is fixed or when it stops having problems. Contact Bob's Space Racers Tech Services with the problem details.

POWER SUPPLY LAYOUT DIAGRAM

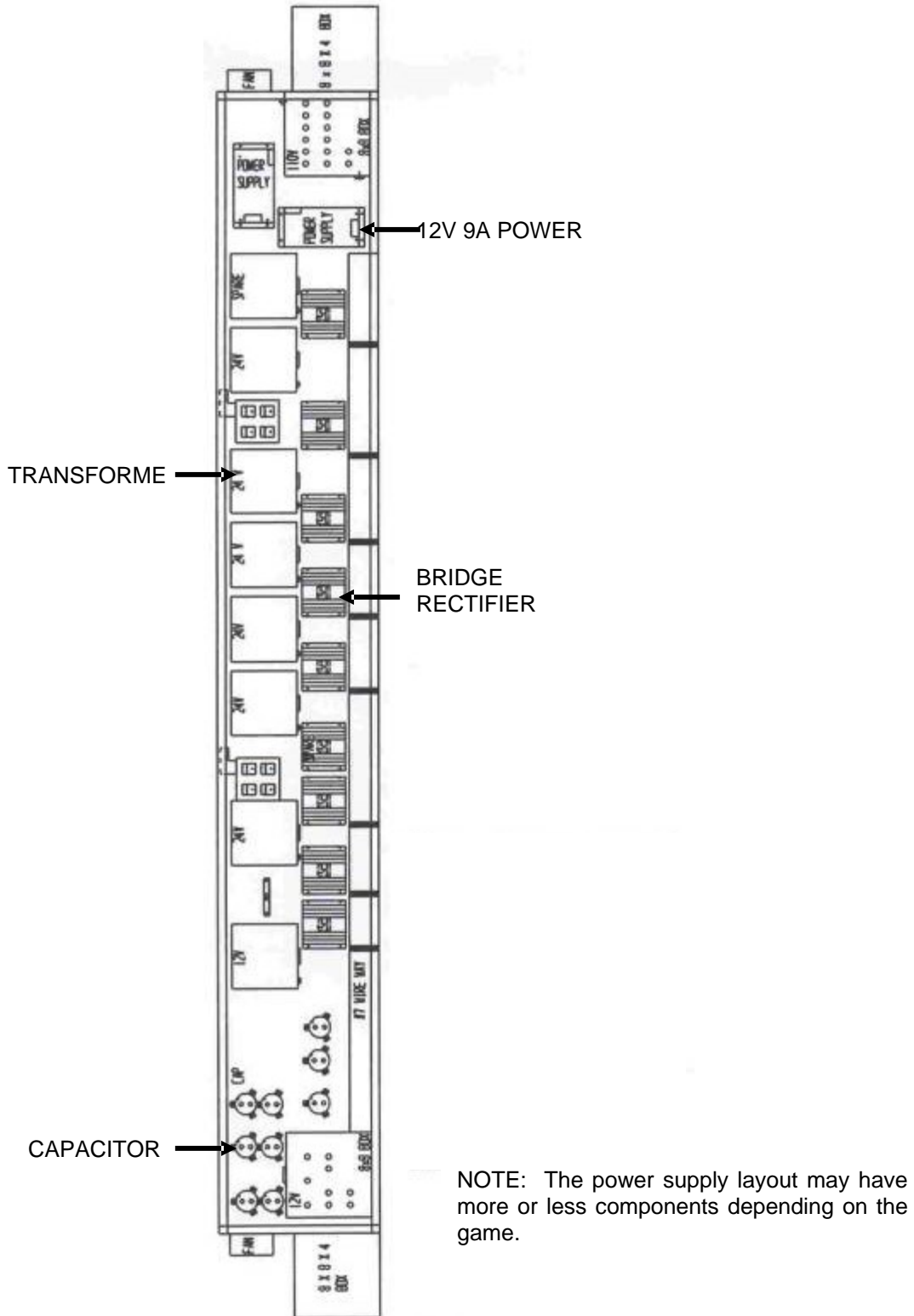

MODULE ELECTRONIC SELF-DIAGNOSTICS

THE MASTER RELAY BOARD

“Green is Go - Red is Stop”: Green LED’s mean everything is connected in proper slots and in proper communication with other components. Red shows an error in your module or module location. Master 1 and units are interchangeable. Master 2 must be in the master 2 slot only. Player clock must be in player clock location only. Your spare Unit or Master 1 module is located in the spare slot, (See Board Layout).

WITH 2400 REV. G. MODULE

Green LED’s mean everything is connected in their proper slots. A blinking red LED means the module is plugged into a wrong location. If the module LED’s flashes at a constant rate it means it belongs in either a master or unit location (they don’t care which) and it’s in the wrong location. If a module flashes twice, and goes out for a period of time, and flashes twice again, that means it belongs in the master 2 position of the master relay board. If the module flashes three times on the red LED and goes out for a period of time, then flashes three times again, that indicates it belongs in the number 3 position or the player clock socket of the master relay board.

RELAY BOARD Overview and Diagram

There are three (3) styles of relay boards, and the style of relay board used depends on the application. The coil voltage comes in on a 10-pin ribbon cable connection to turn the relay(s) ON or OFF. The LED's on the board signal when a relay is ON or OFF. The different styles of relay boards are as follows.

This game uses the following style:

BSR1110

On this relay board there are two (2) 12-pin Molex plugs and one (1) 3-Pin Molex plug. The Molex plugs bring out the contacts of the relay(s), (common, N/O, and N/C). These are used for any voltage level or general application.

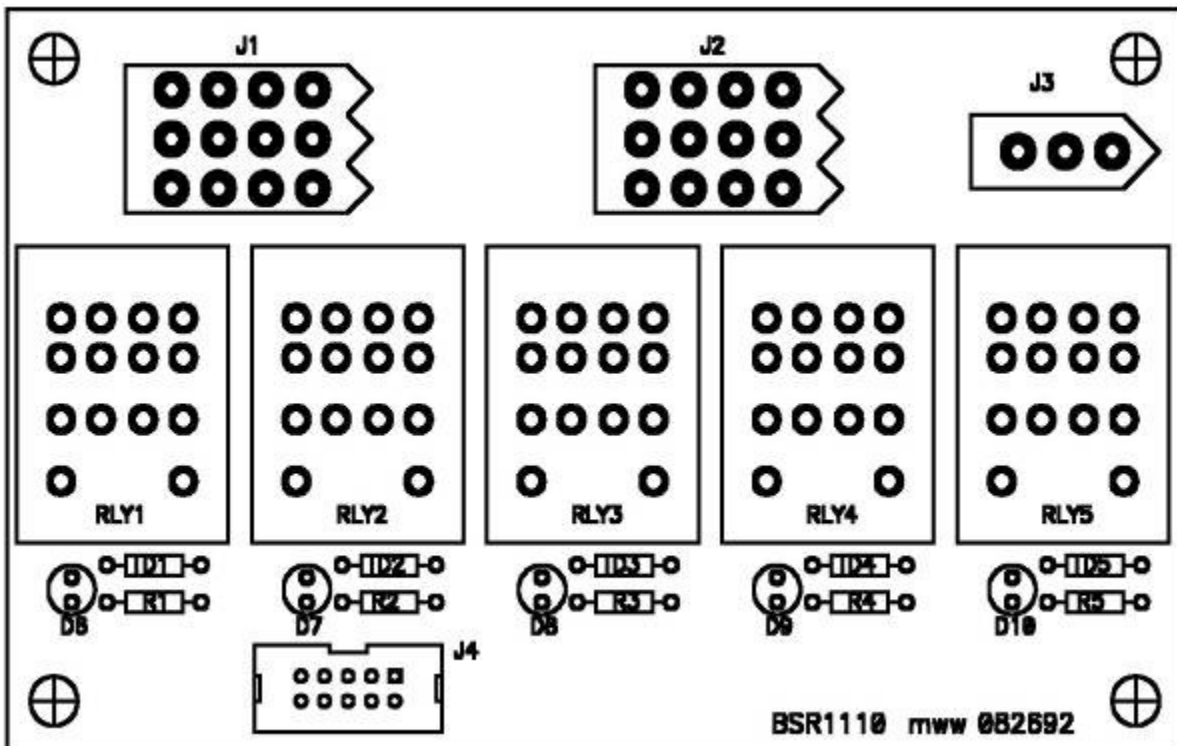

MODULE RELAY BOARD OVERVIEW

The Module Relay board controls the Stepper motor. The module relay board is thoroughly labeled and has indicator LED's for instantaneous indication of game activity.

There are CAT5 (RJ45) connectors for networking multiple units and for the Master board. The master board controls overall function of the entire game (i.e. start, stop, winner determination, etc).

Master board and the On Tap module relay board contain both regulated 12V DC and unregulated 12VDC with the addition of 24VDC unregulated power.

MODULE CHANGES AND UPDATES

When you receive an update or replacement module it can go into one of several sockets on your Master Relay Board. If the module does not have a label on it, you can put it in any of the positions other than "Master 2" or "Player Clock". These specific sockets are labeled on the master relay board. The master relay board is mounted to the far left side of your control electronics box. The master relay board has four (4) sockets, labeled from left to right, "Master 1", "Master 2", "Player Clock", and "Spare".

All of the modules have the same features (other than player clock and master 2). If you receive a player clock module or Master 2 module, they will be labeled as such. If a module is received and it is labeled "Master 1" that means it has a program update for the game. The Master 1 socket has the ability to update the program to the rest of the game.

In order to insert any of the modules you must make certain your game electronics is OFF. (You will notice that the three lights on the edge of the module are out completely.) At that point insert the module into the correct position, removing the old module – if one is there. The module should be inserted so the LED's (small yellow, red and green lights) are toward the bottom. It should plug securely into place. That module should be at the same height as the other modules in place and not at any angle. Now you can apply game power – turn on the circuit breaker or plug it into the wall. All of the modules should light up at least the green lights.

When a master 2 module (which keeps track of what time it is) is inserted into a game; the time must be set for your time zone – go to the Multi-Line LC Display Box with the accounting features. Hold down the two middle buttons (the "UP" and "DOWN") on the display. (See ACCOUNTING SYSTEM in the APPENDIX for more instructions and a diagram on this LCD box.) Then turn the key to the "ON" position, it should display "YEAR =" and a value. After setting the value you want by using the "UP" and "DOWN" buttons PRESS the "ENTER" key.

The four buttons have the following features; the left-hand button is "MODE" as it says in the bottom of the display. When you press this button it advances to the next option without modifying any settings. The next two buttons are "UP" and "DOWN"; to change the value of a given setting. When you change the value in the display the setting does not take until you press the "ENTER" button which is the far right button. If you press the "MODE" button, instead of "ENTER" you advance to the next location without changing the option; even though you saw the value change. You must press "ENTER" for it to accept the change. The year value is a two digit number from 00 to 99 (this program takes into account the year 2000) and is accurate to the year 2090.

Now, set the month; which is from 01 for January to 12 for December. Press the "ENTER" button after that value is set correctly. Next set the time; there is no AM or PM value, we use the 24 hour format. If you want 8:00PM the setting would be 8 + 12 or 20 for the value then press "ENTER". The next setting is for minute; set the correct number of minutes and press

MODULE CHANGES AND UPDATES

“ENTER”. Turn the key back to the “OFF”, and the Multi-Line LCD Box will return to its normal accounting function.

If you receive an updated Player Clock module there are no settings for it, when plugged in it will do its job.

If you receive a module and it has no label and it is a replacement you will need to do a systems download in order to get your game's current program into the replacement module. If you have received an update Master 1, or program, the module belongs in the Master 1 location and a download needs to take place in order for the rest of the game to have all the updates.

To download the programs to the rest of the game, with the game power on (locate the game MULTI-LINE LCD unit) turn the key to the “on” position. The Multi-Line LC Display should read “GAME TYPE” and a value. (Refer to OPTION REGISTER SETTING INSTRUCTIONS for complete instructions and diagram) Press the left “MODE” button, this will cause the LCD screen to advance through the options. With the left button still depressed, press the far right button (“ENTER”) for at least one (1) second. After two (2) seconds the display will say “DOWNLOADING UNIT”. Now you can let off of the buttons and turn the key to the “off” position, and the new/replacement module will download the program to the rest of the modules ensuring no conflicts between any of them.

During the time it takes to download you will see yellow and red lights on the modules begin to flash or turn dim, this is informing you that the programs are actually being downloaded into the modules. When that is complete the red light will go out and the yellow and green light will come on bright.

If you insert a module, and after power up, you see a red light is flashing, this indicates a module is plugged into the wrong location. If the module flashes at a constant rate, it means it belongs in either a master or unit location (they don't care which) and it's in the wrong location. If a module flashes twice and goes out for a period of time and flashes twice again, that means it belongs in the master 2 position of the master relay board. If the module flashes three times on the red LED and goes out for a period of time, then flashes three times again, that indicates it belongs in the number 3 position or the player clock socket of the master relay board.

If you have any problems during the downloading process, or if the game is not working correctly after you have completed the download, please call Bob's Space Racers® for further technical support help. Try to identify which lights are “ON” and on which module they are located. Generally speaking, you should see that most of the modules have the same lights on, in the same pattern. There may be one or two that are different. Note which locations that are different, to aid in troubleshooting with a technician.

STEPPER MOTOR CONTROLLER BOARD OVERVIEW

The Stepper Motor requires a Controller Board to operate.

The operation of the Board is as follows:

Connector J2 supplies +12VDC (pin 4), NEG reference (pins 2 and 3), and +24VDC (pin 1) to the board. The motor is connected to J1. The signal (power) to the motor is a "chopped" H-bridge bipolar output. The input signals from the Controller Board (step and direction) come in on connector J3.

The inputs are Opto-coupled by U1 (PC817-4), sent to U4, a translator/generator (L297) and then final output driver (L298N). A L6210 diode bridge is attached to the outputs for protection from back EMF.

To increase motor life, and decrease heat, we use a timing circuit that detects motor "steps", after about 2 seconds, if U2 (SN74123N) does not sense a signal, the board will go into reduced power mode. JP2 on both boards changes whether the motor is in full or half step mode. Normally, JP2 is not jumpered and the motor is in half step mode. JP3 is almost always jumpered and supplies 12VDC to the Opto-couplers. JP4 is available for an auxiliary fan, although one should not be required. Never remove or add any jumpers unless you are instructed by a technician from Bob's Space Racers® to do so.

STEPPER MOTOR BOARD WIRING DIAGRAM

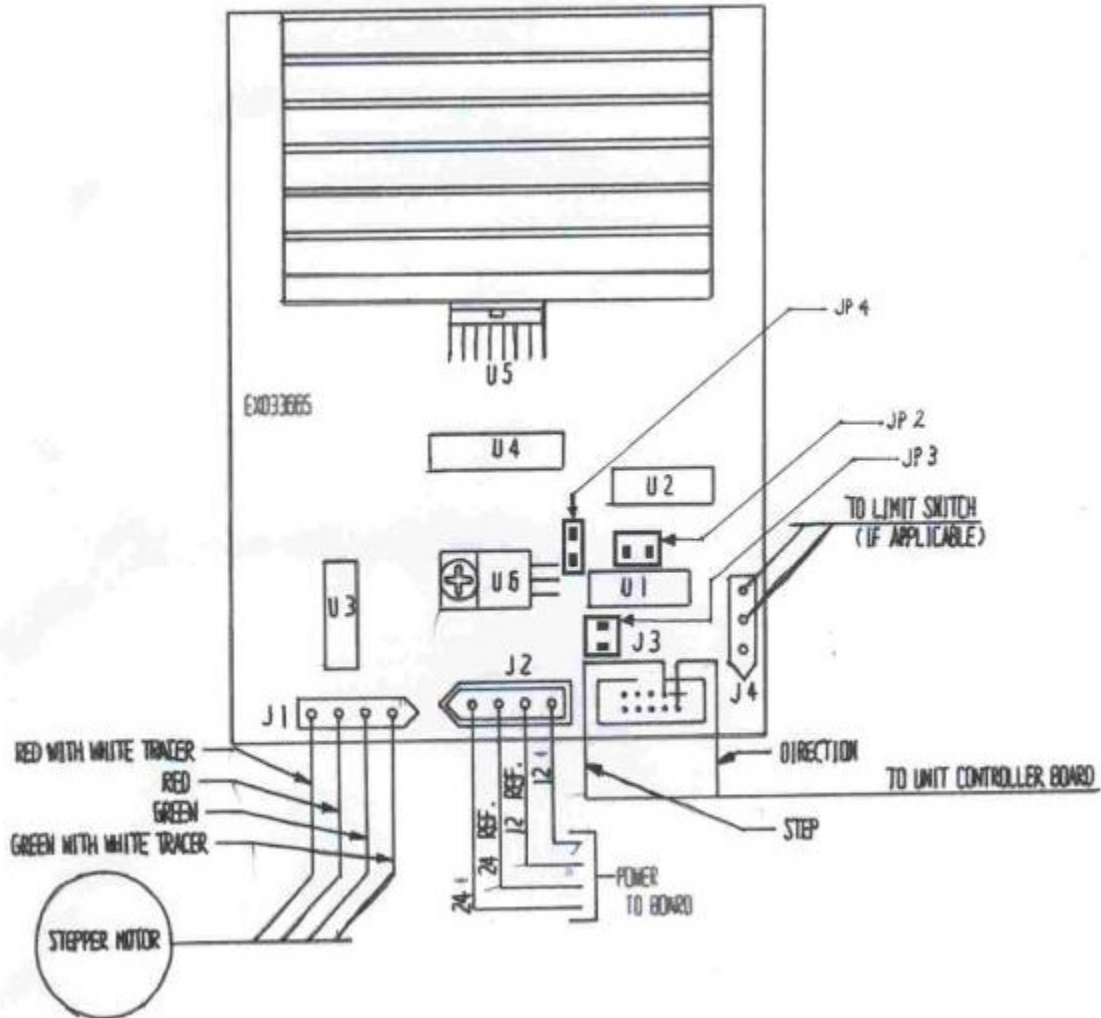

USER JUMPER PROCEDURES

JP 3:

- If the 4-pin Molex plug (J2) for power is completely populated (filled), then remove JP 3 (no jumper). Wire colors: orange, blue, red and black.
- If J2 has only two (2) wires connected, then a jumper must be on JP 3 to distribute power correctly through the ribbon cable. Wire colors: orange and blue.

JP 2:

- JP 2 has a jumper on it for On Tap Games ONLY.

Note: There is also a capacitor soldered to the backside of the stepper motor board for Rev. 'C' and Rev. 'D' boards.

TROUBLESHOOTING – 2400 SERIES ELECTRONICS

PROBLEMS/CAUSES

PROBLEMS WITH THE GAME

Game Will Not Turn On

Bad Footswitch

Bell Does Not Work At All

No Power

Bad Relay

Bad Bell

SUGGESTED FIX

Check continuity on foot. If bad, replace.

Check for 12VDC at the Relay Board. Check wiring.

Swap Relay with another one; replace, if necessary.

Check Bell by plugging into the end of an extension cord. (The Bell has a standard wall plug jack on it).

MISCELLANEOUS

GAME PARTS LIST

<u>PART #</u>	<u>DESCRIPTION</u>
WX010040	Auto Ball Stop
EX033511	LCD Box Assembly, Multi-Line
E0029800	ID Light 14V, Amber
E0029790	ID Light 14V, Red
EX033665	Stepping Motor Board Assembly
E0031100	Large Bell, 6"
E0900000	Printer
E0029130	Fluorescent Tube
MX041000	Win, Place, Show Display
E0030630	12V Happ Beacon Base
E0030632	Chrome Beacon Ring
E0020635	Blue Beacon Dome
E0028015	Remote Control Conversion Kit, w/Remote
E0003800	12V DC 14-pin Relay
E0007680	Stepper Motor
E0013300	Standard YZ Micro-Switch
E0013900	Cherry Microswitch
E0013905	Actuator Wire
E0013910	Retaining Washer
E0028500	40W, 120V Bulb for Top Globe
E0029105	27W, 14V, 1A Bulb for Blue Beacon
EX0033100	Footswitch Assembly
EX033600	Auto Ball-Stop Assembly
M0004575	Cue Ball
M0005300	20oz Can CRC Spray
M0006500	Heat-Proof Grease
M0010800	Screwlox Driver, #2

APPENDIX

ACCOUNTING SYSTEM

2400 G MODULE ELECTRONICS' ACCOUNTING SYSTEM OVERVIEW

The 2400 G Module Electronics' Accounting System is integrated into the game's own electronics. This means there is no wiring harness to connect it to the rest of the game or to individual units.

The external wiring for this accounting system includes two (2) cables that are plugged into the Master Relay Board. There is a connector marked "MASTER 2 PRINTER PORT" on the Master Relay Board, which has a cable that runs down to the printer in the game, and a Ribbon Cable above the Spare Module that is labeled "ACCOUNTING LCD". Even with the printer or the LCD cable not plugged in, the accounting system continues to accumulate information. Whenever a good LCD or printer is plugged in, all the tallied information will be available.

To locate the BSR MULTI-LINE LCD for the accounting system simply read the display. The message on the display will read out "ACCT2400" on the bottom left side of the display. When you turn the key on, it will display "PRINT REPORT?" across the top. On the bottom line it will say "NEXT" above the left button and above the far right it will read "YES". If you press the button below the word "NEXT", it will sequence through a number of settings from "PRINT REPORT", to "HI PLAYERS", to "HI GAMES", to "LO PLAYERS", to "LO GAMES, and then, to "ERASE DATA". If you press the button below the word "YES" when the display reads "ERASE DATA" it will clear the data and default back to "PRINT REPORT" display.

MULTI-LINE DISPLAY DIAGRAM

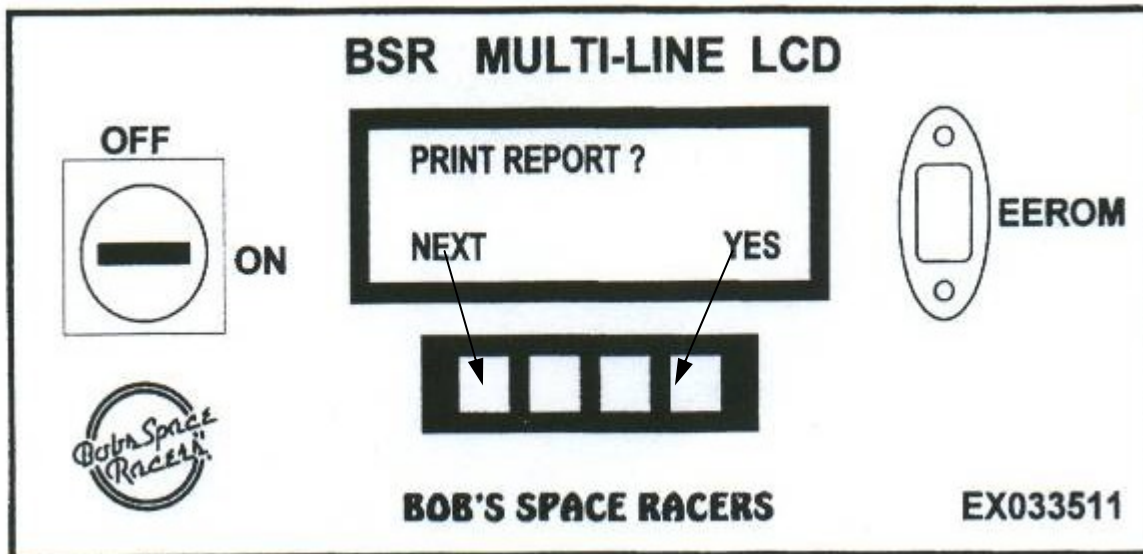

2400 G MODULE ELECTRONICS' ACCOUNTING SYSTEM OVERVIEW

```

Bob's Space Racers
AccuTrak Accounting Report

Report Date: 05/12/2003
Report Time: 10:17:06
Game ID:373

Last cleared at: 05/06/2003 12:33:38

Level 1 Report:
Players in $ 2 Games = 00000
Total $ 2 Games      = 00000
Players in $ 1 Games = 00000
Total $ 1 Games      = 00000
Total $              = 00000

Reset Players        = 00000
Reset Games          = 00000
Reset $              = 00000

Level 2 Report:
Games with 1 player = 00000
Games with 2 players = 00000
Games with 3 players = 00000
Games with 4 players = 00000
Games with 5 players = 00000
Games with 6 players = 00000
Games with 7 players = 00000
Games with 8 players = 00000
Games with 9 players = 00000
Games with 10 players = 00000
Games with 11 players = 00000
Games with 12 players = 00000
Games with 13 players = 00000
Games with 14 players = 00000
Games with 15 players = 00000
Games with 16+ players = 00000

Level 3 Report:
Non-resetable Counters:
Players in $ 2 Games = 0000000
Total $ 2 Games      = 0000000
Players in $ 1 Games = 0000054
Total $ 1 Games      = 0000029
Reset Players        = 0001298
Reset Games          = 0000000

Level 4 Report:
Hourly Reports:
  Date-Time  Games  Players  Receipts
05/08 12:00  00    00000    00000
05/08 13:00  00    00000    00000
05/08 14:00  00    00000    00000
05/08 15:00  00    00000    00000
05/08 16:00  00    00000    00000
05/08 17:00  00    00000    00000
05/09 10:00  00    00000    00000
05/09 11:00  00    00000    00000
05/09 12:00  00    00000    00000
05/09 13:00  00    00000    00000
05/09 14:00  00    00000    00000
05/09 15:00  00    00000    00000
05/09 16:00  00    00000    00000
05/12 20:00  00    00000    00000 *
```

When the display reads "PRINT REPORT" and you press the right hand button below the "YES", as shown on the previous page, a report will be printed, similar to the one shown on the left of this page. (See example at left). If no report is printed then you will need to make certain the printer is turned on. A green light on the face of the printer unit will come on when the printer has power to it. Also, check the paper supply to the printer; the paper is found inside the unit. If these items are fine and you still have no printing capabilities, then you will need to check the connection on the Master Relay Board. Examine the "MASTER 2 PRINTER PORT" on the Master Relay Board and make certain it is securely plugged in.

A printed report will have a heading that includes: 1) the Current Time and Date; 2) the Game Identification Number; and, 3) the Last Time and Date the Information was cleared from the Accounting System. Note: You should recognize it as the last time you cleared your meters! The report will then print a LEVEL 1 report providing you with the totals since the last time the system was cleared.

This Accounting System will also keep track of the total dollars for you. If you have the price sign option and if the price sign reads correctly, then this system will accumulate how many dollars the game was supposed to bring in since the last time it was cleared.

After Level 1, the report prints Level 2 which provides you with the number of races that were 1-player games, 2-player games, 3-player games, et cetera, up through 16-player games. If you have more than 16 units, then all of the games played with 16 or more players or more will be tallied on the "16+ players" line on the printed report.

Below Level 2 is Level 3, this consists of a set of total races that have ever been played. These values do not get cleared when you "ERASE DATA" and are considered non-resetable. (This part replaces the Mechanical Meters you may have in some of your older games).

2400 G MODULE ELECTRONICS' ACCOUNTING SYSTEM OVERVIEW

The last part to be printed is Level 4, which is an hourly report. This informs you of how many games were played each hour the machine was powered up (turned on). If the machine was not powered up there will be no report for that time frame.

When you are done using the BSR MULTI-LINE LCD, you need to turn the key to the "off" position. This key needs to be in the "off" position during game operation as well as when the game itself is powered down – it will not affect the operation of the game. If the key is left in the "on" position during the game operation it will not affect the game, nor will it affect the function of the BSR MULTI-LINE LCD. However, if the key is left in the "on" position it will affect your security! It will allow anyone to have access to your game's financial information and they will be able to erase it before you have a chance to record it in your books! It is very important that you do not leave the key in the "on" position for safety and security reasons!

LIQUID CRYSTAL DISPLAY MODULE OVERVIEW

The Liquid Crystal Display (LC display or LCD) is permanently mounted inside the electronics enclosure. The LCD enables the operator to view the number of games run and how many players there have been. Also, it is used to monitor the number of high/low players, the number of high/low games, and the operator time (in minutes) – for up to two (2) operators – in your game. To read the contents of the LCD, turn the key to the 'on' position (this key is used for safety precautions so that unauthorized personnel cannot clear it). The LCD will reveal the data. Press 'mode' to sequence through the data; once completed, it will read 'erase data'. Press 'enter' to clear the contents, and turn the key to the 'off' position. Compare this information with the mechanical meters. (For other options available on the LCD, see the 2400 G Module Electronics' Accounting System Overview.) The circuitry inside the LCD module is a BSR serial-to-parallel interface for the actual LCD, which is an "intelligent" module (meaning it has its own microprocessor).

MULTI-LINE LCD DIAGRAM

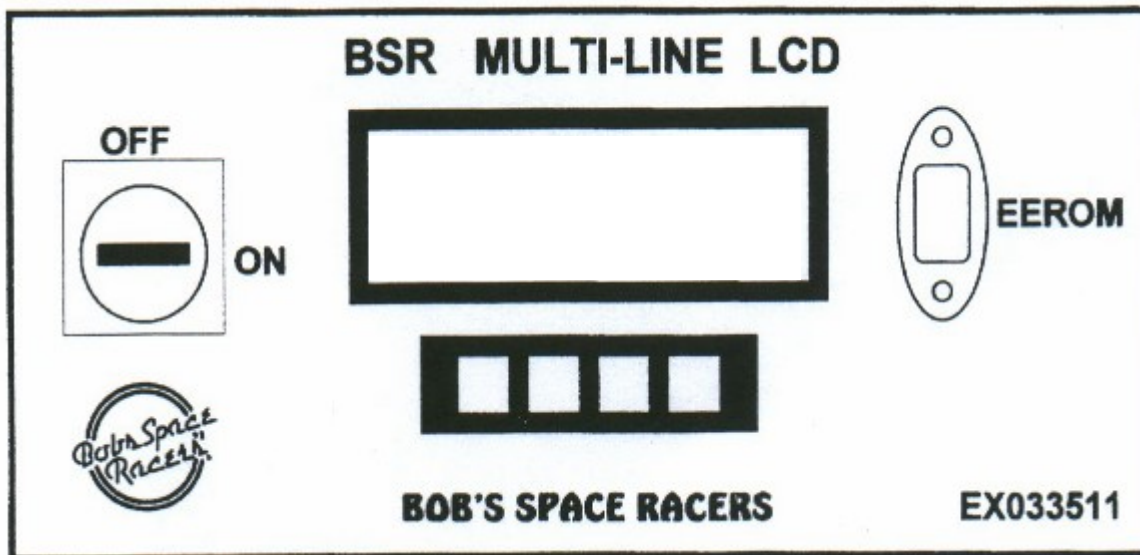

LIGHTING

LIGHTING OVERVIEW

Flashers

MECHANICAL FLASHERS:

Overhead lighting is an option on many BSR games, and standard on BSR trailers. Each game has multiple light tracks, a flasher unit, and overhead mounting braces. In the past we have used a three (3) terminal flasher unit, 33-C3 (66-C3 for high amperage use); now a four (4) terminal flasher unit, 33-C4 (66-C4 for high amperage use), is being used.

Trailer model games require three (3) flasher units, one (1) for the marquee, and two (2) for the awnings. The awnings are separated into two sections: one long and one short for each of the flasher units, (See Figures #1 and #2).

Each of the four terminals on the flasher unit attaches to a certain number of sockets on the light bars. As the motor turns, the cam that is attached to the motor shaft will open and close the contacts, turning the lights on and off.

*** CAUTION: Turn OFF all lighting power when troubleshooting either type of flasher box (120V AC or 220V AC)! ***

During the life of the flasher unit, the contact posts may need to be cleaned, use only contact cleaner to do this! Do not use abrasive cleaners, brushes, filing, or any other non-approved cleaning product or technique to clean the contact posts (as that will damage them)!

You may need to adjust the contact posts at some point. To do this, simply turn the cam so the middle of the gear is under the contact wheel. (The teeth of the gear should be on either side of the contact wheel.) Using a screwdriver, loosen the nut on the contactor post and lower the contactor by tightening the screw adjustment. The contact pads should be approximately 1/16" to 3/16" apart. If they touch, the light will be on all of the time. When the contactor pads have the correct gap distance from each other replace the nut, and tighten it. NOTE: Flashers should be mounted on three (3) corners, not four (4), to prevent binding.

Each flasher unit has a model number, which is located on a decal on the flasher unit itself. This model number enables you to order parts for the particular flasher unit you have. If you can't find the model number on your flasher unit, then count the number of contact posts on your flasher unit; there is either three (3) or four (4) contact posts, and they are either in a single row (Figure #1) or a circle (Figure #2).

LIGHTING OVERVIEW

Flashers

ELECTRONIC FLASHERS:

Electronic Solid State Flasher Unit(s) are based on a 2300 Microprocessor and have been placed in some games as early as 1996. They consist of a 2300 Series Microcontroller that drives either four (4) or eight (8) 25 amp solid state relays, depending on the lighting application. Each unit, also, has a self-contained 12V DC power supply, (See Figure #3).

OTHER

FLUORESCENT LIGHTING

Fluorescent lighting is used on all trailer models, and on some park models, to light up parts of the game. We use standard light fixtures that can be sourced from a local hardware or building supply store. Most of the fixtures use replaceable ballasts that can be obtained from local home repair stores or sourced from Bob's Space Racers®, Inc.

Figure #1

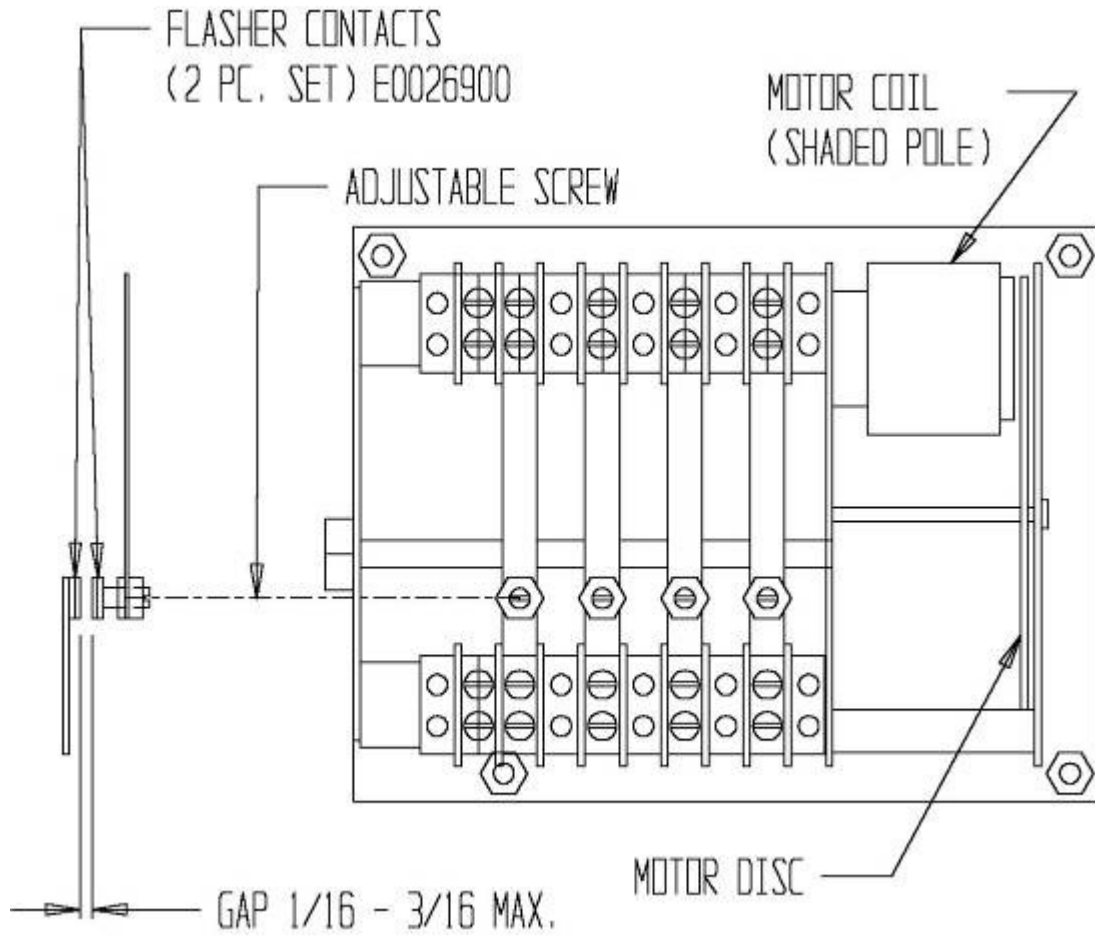

Figure #2

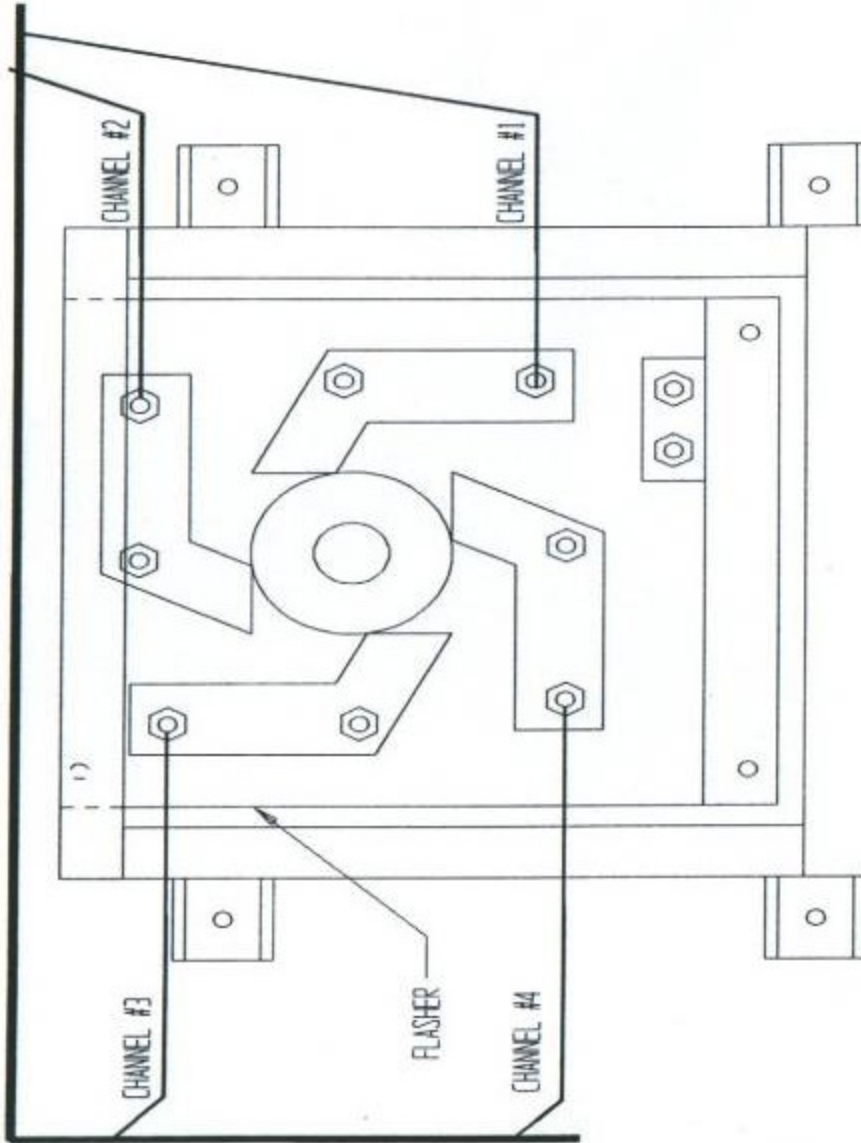
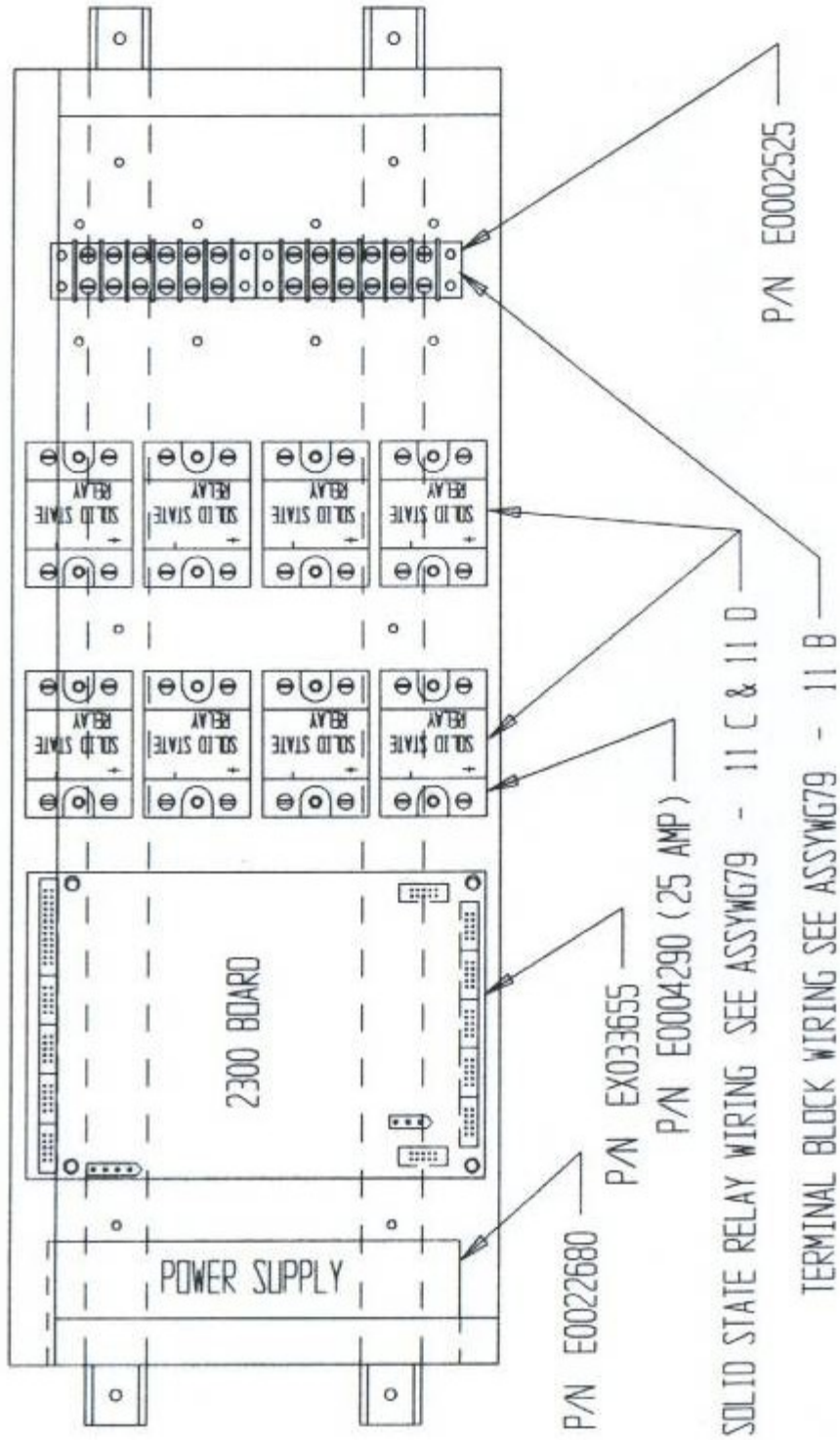

Figure #3



TROUBLESHOOTING - LIGHTING

PROBLEMS/CAUSES

Overhead Lights Don't Work At All

No connection

No 110V AC supply

Bad motor

Some Lights Don't Work

Bad connection

Contacts misaligned or dirty

Bad bulb

Bad socket

SUGGESTED FIX

Check amp connector and all Molex plugs for each track of lights for a secure fit.

Check voltage at the motor. If no voltage, follow wiring back to 4X4 box and check the fuse and/or wiring inside. If you have 110V AC at the motor and it still doesn't work, it's probably a bad motor.

Replace flasher unit if necessary.

Check bulbs to make certain there is a secure fit into the socket.

Check flasher contacts inside the flasher unit.

CAUTION: 110V AC – unplug the game power. Carefully clean each contact with contact cleaner and realign contact posts, if necessary, to its mating contact.

**** DO NOT sand contacts! Check gap between contacts, MAX = 3/16", MIN = 1/16" ****

Swap bulb with a known good one and replace if necessary.

Retwist light socket connection and replace socket if necessary.

TROUBLESHOOTING – LIGHTING

PROBLEMS/CAUSES

Fluorescent Lights Will Not Light Up

Bad light

Bad ground

Bad ballast

Fluorescent Lights Will Not Light Until Someone is Standing Next to Them

Bad ground

SUGGESTED FIX

Change light bulb.

Make certain fixture has an earth ground properly connected. (Very important!)

Replace ballast.

Make certain fixture is properly grounded and check the ground on the game.

LIGHTING PARTS LIST

<u>Part Number</u>	<u>Description</u>
E0026400	33C3 FLASHER UNIT
E0026500	33C4 FLASHER UNIT
E0026600	66C3 FLASHER UNIT
E0026700	66C4 FLASHER UNIT
E0026800	66C FLASHER CONTACTS/PAIR
E0026900	33C FLASHER CONTACTS/PAIR
E0028500	40 WATT BULB 120V AC
E0028600	25 WATT RS BULB 120V AC
E0029390	18" FIXTURE, 15 WATT
E0029130	15 WATT FLUORESCENT TUBES
E0028140	15T6/145V GE BULB
E0028200	150 WATT, WHITE FLOOD LIGHT
 <u>Interior/Exterior – USA</u>	
E0028700	11S14 CLEAR BULB (PHILLIPS)
E0028700-TR	11S14 RED BULB (GE)
E0028700-TB	11S14 BLUE BULB (GE)
E0028700-TY	11S14 YELLOW BULB (GE)
E0028700-TG	11S14 GREEN BULB (GE)
E0028700-TO	11S14 ORANGE BULB (GE)
 <u>Indoor Only – Imported</u>	
E0028710-TG	GREEN BULB (SIVAL)
E0028710-TB	BLUE BULB (SIVAL)
E0028710-TR	RED BULB (SIVAL)
E0028710-TY	YELLOW BULB (SIVAL)
E0028710-TO	ORANGE BULB (SIVAL)
 <u>Small Bulbs – USA</u>	
E0028800	10S11N CLEAR BULB (PHILLIPS)
 <u>Small Bulbs – Imported</u>	
E0028810-TB	10S11N BLUE BULB (SOBYCO)
E0028810-TR	10S11N RED BULB (SOBYCO)
E0028810-TY	10S11N YELLOW BULB (SOBYCO)

OMNI PRINT OM-200

OMNI PRINT OM-200 DIP SWITCH SETTINGS

Your BSR Multi-Line LCD will inform you of the program version you have in the game (as shown in Diagram 1 below). If you have program version 2416 or 2417, then you will set your printer dip switches to version A. If you have program version 2418, then you will set your printer dip switches to version B, (Both are shown in Diagram 2 below).

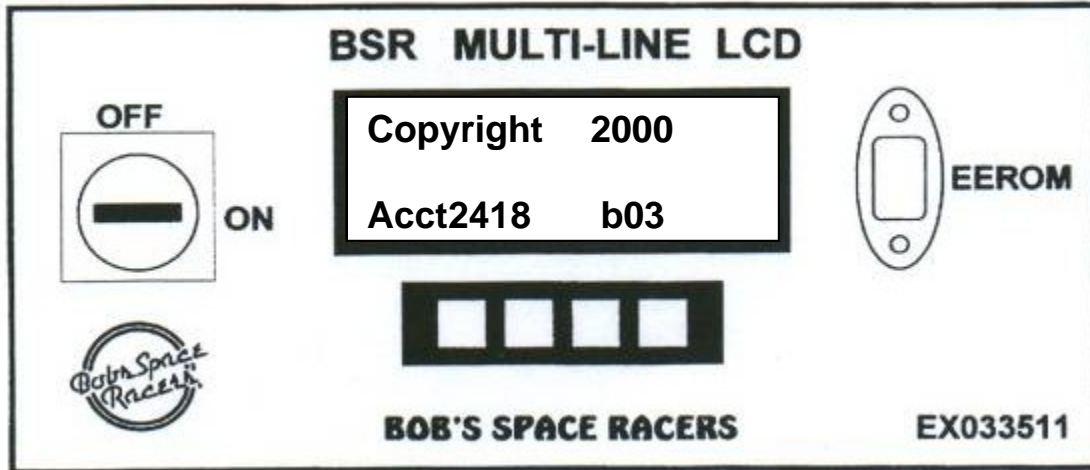

DIAGRAM 1

In this example program version 2418 is in the game. So, you would set the printer dip switches to version B (using the instructions in Diagram 2 below).

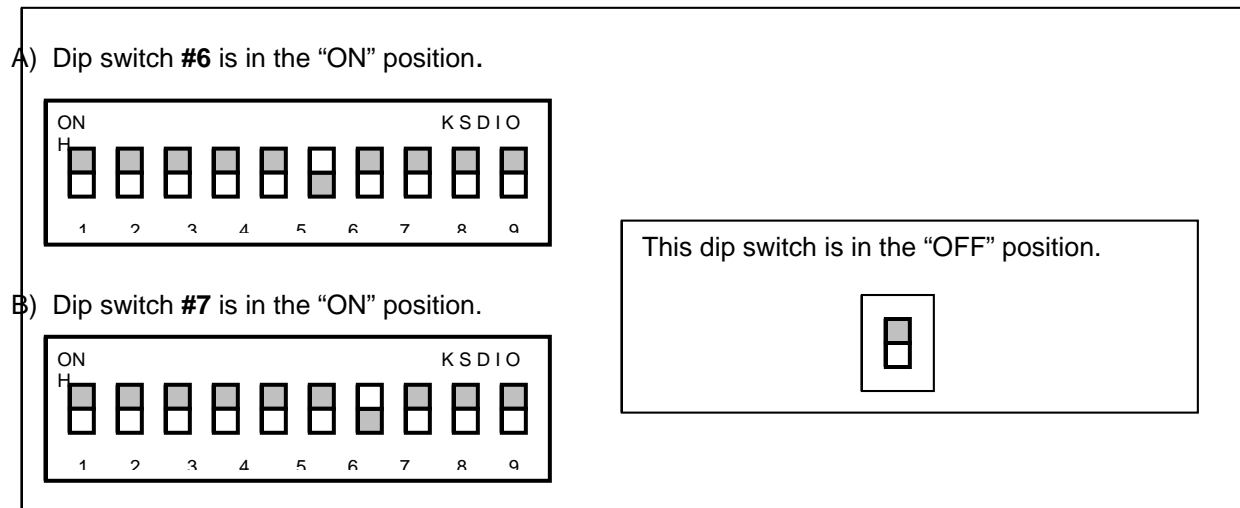

DIAGRAM 2

Note: The printer dip switches are found on the back of the printer under the (green) rubber oval.

SOUND SYSTEMS

SOUND SYSTEM OVERVIEW

Over the years, Bob's Space Racers® has updated the sound systems to accommodate the needs of our customers. The original sound system was a MacKenzie Cartridge, which was a small silver tape cartridge. Next was a Leer Cartridge, which was an 8-track tape. Then a DMR MacKenzie Sound, which was in a gold case with a slide-in cartridge. We also use either the DMR-PX Mackenzie Player or the Clever Device Sound Sequencer. The DMR-PX Mackenzie Player can play only a single sound. The Clever Device Sound Sequencer has the capacity to play from two to eight (2-8) sounds. We presently have a new innovative sound unit, the BSR Sound Unit, which plays up to 50 songs.

AMPLIFIERS

The amplifiers we have used over the years have, also, changed. Originally we used a Bogen Amplifier which had a 70V speaker system. The Yorkville Sound 4200 and KMD 4200 Amplifiers were the next ones used beginning in the early 1980's. They are similar in operations with only a cosmetic difference on their face units. The Yorkville Sound 6400 Amplifier was used after that. This was used in some Whac-A-Mole® trailers because they have more speakers than other games. Presently we use a Yorkville Sound MM4, or MP4, Amplifier System. This unit has more power and is more user-friendly. The hook-up of all of the above amplifiers is pretty much the same: power, speaker, etc.

The current sound system comes equipped with overhead microphone cables and includes a hand-held microphone and wireless microphone system. These kits are designed to operate at different frequencies for the various games Bob's Space Racers® manufactures. The transmitter and receiver are set for the same frequency of operation. We have selected different channels for each of the games to minimize interference of signals from other sound systems.

We also have CD Players available. We originally used a Pioneer 6-disk player, but have switched to a Sony single-disk player. This switch was done to reduce the maintenance and to simplify the operation.

If you are interested in updating your sound system to one of the newer systems available, please call us at 386-677-0761 and ask to speak with a technician. The technician will help you determine exactly what is needed for your system to be updated.

BSR SOUND UNIT

Depressing the “#” key on the keypad repeatedly, increment the sounds through the five sections. One can flip through the sections while a sound is playing without interrupting the sound. A sound that is playing will only be interrupted if the operator chooses to play another sound or a game is started.

After accessing the desired section, press keys “0” through “9” to hear the corresponding sounds.

Press the “*” key from any section at anytime and the system will play a song from the *Game Music* section. Press the “*” key X times, and the system will play X songs with a ten second pause between songs. This cycle will be interrupted if any other key is pressed.

The system also has an automatic mode. While in automatic mode, the system will automatically activate if left idle for two minutes. The system can be set to play any sequence of songs, gimmicks, and operator commands in ten (10) second intervals, until a button is pressed or until a game is started.

The system can be set to the automatic mode by holding the “#” key for ten (10) seconds while in the *Game Music* section. After ten seconds, the *Game Music* light will blink off and on in two-second intervals. Depending on when the key is released, the system will be enabled or disabled. If the key is released while the light is on, the system will be set in automatic mode. If the key is released while the light is off, it will not be in automatic mode.

Starting a game will cancel any sound that may be playing, and will play the *game music* for the race. For each race, the system will play the next song in the *Game Music* section.

FACE PLATE DIAGRAM



REPLACING THE MUSIC CARD

1. Unplug the system.
2. Remove the four screws on the face of the sound unit.
3. Carefully remove the faceplate (diagram above) and lay it face down. The green circuit board should be facing you.
4. Refer to the circuit board diagram below, and gently pull out the **sound** card.
5. Insert the other card in the same manner, (refer to the same diagram below). The shiny gold section of the sound card should be facing you. Insert gently until it will go in no further.
6. If you insert the sound card upside down, the card socket will not allow you to insert it fully. **DO NOT FORCE THE CARD IN. IT SHOULD SLIDE IN EASILY.**
7. Replace the faceplate and screws, and plug in the system.

CIRCUIT BOARD DIAGRAM

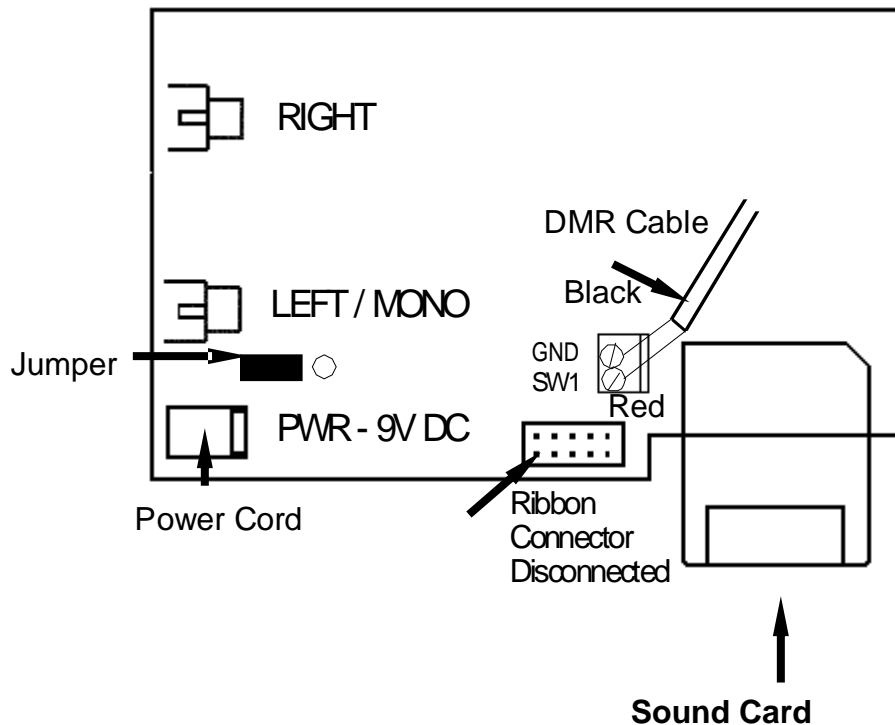

SWITCHING FROM MANUAL MODE TO AUTOMATIC MODE

1. Remove the faceplate from the BSR Sound Unit.
2. Detach the DMR cable, as it is no longer needed. Remember to tape the ends.
3. Remove the power cord from the box, as the unit will get its power through the ribbon cable. Do not leave the power cord inside the box. If it accidentally touches the circuit board it may burn out the unit.
4. Move the black jumper down towards the ribbon connector.
5. Connect the ribbon cable.
6. Replace the faceplate on the BSR Sound Unit.

AUTOMATIC MODE DIAGRAM

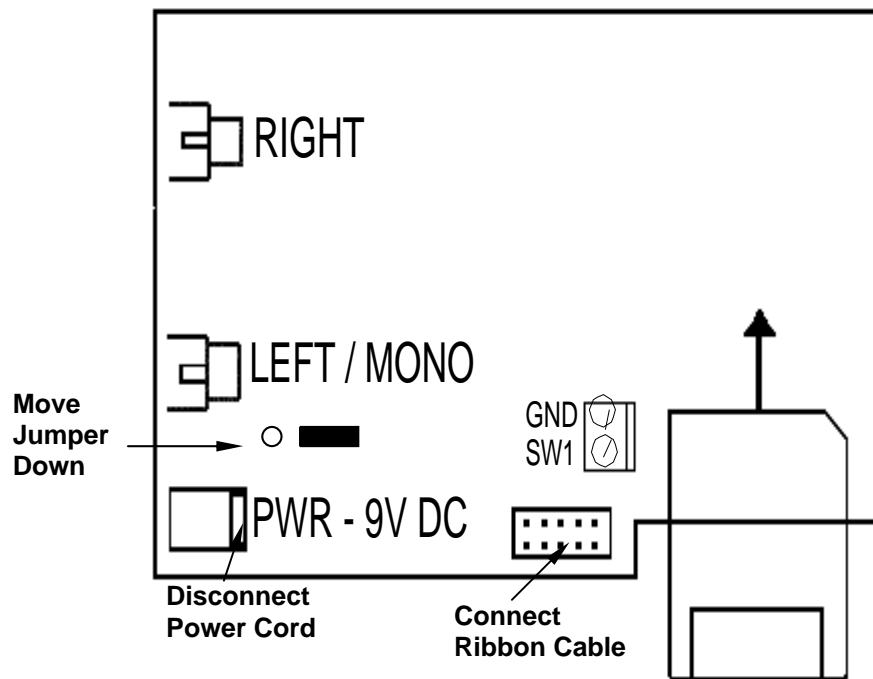

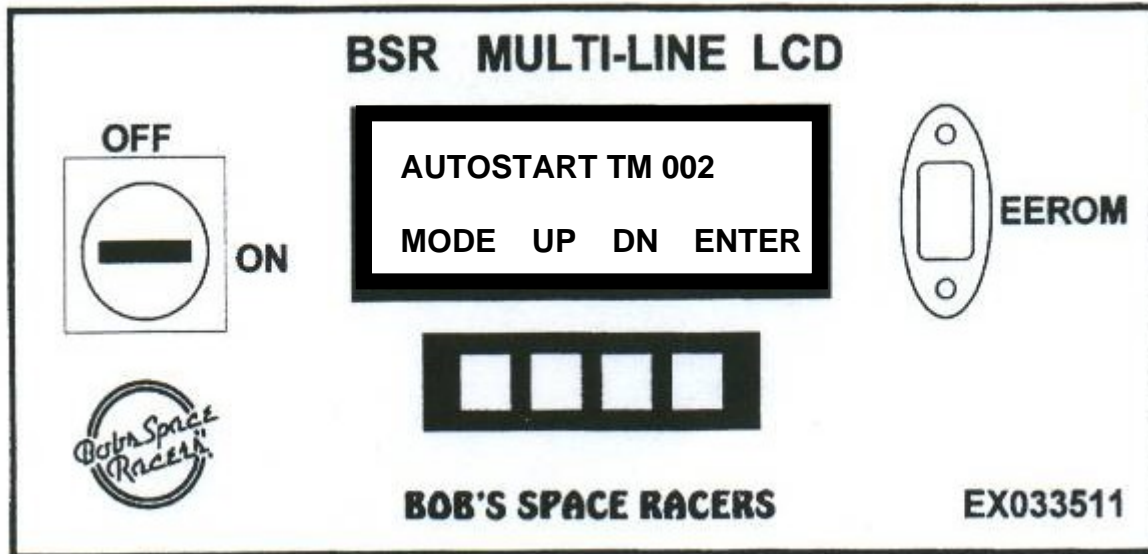

Note: Set "AUTOSTART TM" to "002" for footswitch sounds and instructional messaging.

SOUND UNIT WITHOUT THE RIBBON CABLE

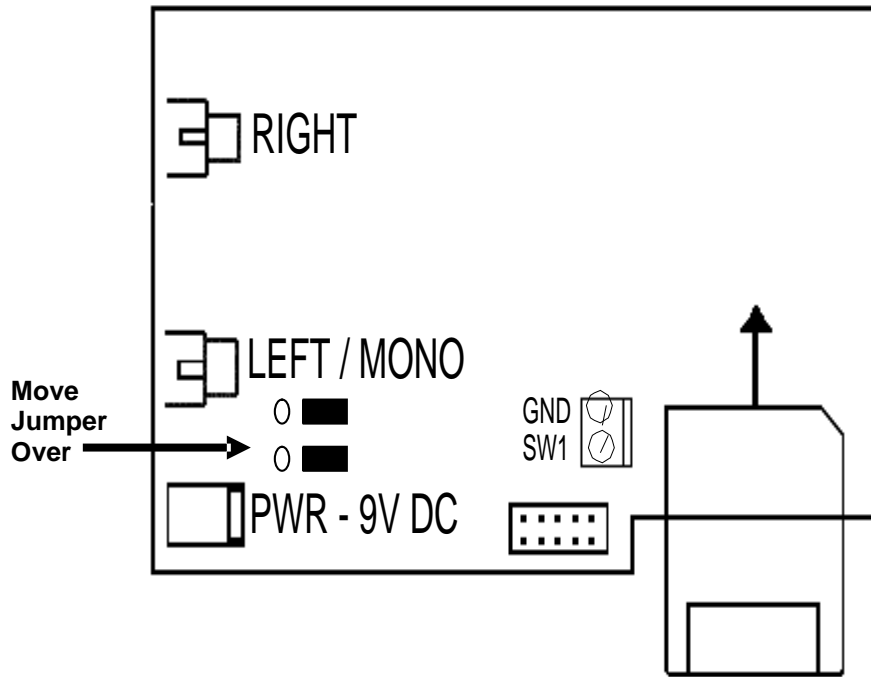

In the event your ribbon cable becomes damaged, broken or shorted, disconnect or unplug the ribbon cable. Ensure that the 22 gauge red and black wires are properly connected to “GND” and “SW1”. Plug in the 9V DC – 12V DC power supply and ensure that the phone/RCA cable is plugged into either “RIGHT” or “LEFT” female phone jack.

Do not use both the ribbon cable and the 9V DC power supply together, (Use one or the other).

Once the correct power supply and jacks have been properly installed, the final adjustment will be to move the black jumpers over.

○ ■ This configuration supplies power through the ribbon cable.
○ ■

■ ○ This configuration has power supplied by the 9V DC – 12V DC power supply.
■ ○

Operator Accounting System



Bob's Space Racers Incorporated.

427 15th STREET • DAYTONA BEACH • FLORIDA • 32117

PHONE **386-677-0761** FAX **386-677-0794**

WWW.BOBSSPACERACERS.COM

Federal Communications Commission (FCC) Regulations

This equipment has been tested and found to comply with the limits for a Class B digital device, pursuant to part 15 of the FCC Rule. These limits are designed to provide reasonable protection against harmful interference when in commercial installation. This equipment generates, uses, and can radiate frequency energy, and, if not installed and used in accordance with the instructions, may cause harmful interference to radio communications. However, there is no guarantee that interference will not occur in a particular installation.

Warning: Changes or modifications made to this equipment, not expressly approved by Bob's Space Racers® Inc., or parties authorized by Bob's Space Racers® Inc., could void the users authority.

BSR-OAS TABLE OF CONTENTS

Description:

- Overview -1-
- I-button Description and Picture -2-
- I-button Module Description and Picture -2-

Before Using..., You Must –

A) Set up:

- Printer -3-
- Time and Date -3-
- Number of Copies -3-
- Auto-Logout -3-
- Game -4-
- Price Point -4-
- Game Number -5-

AND

B) Program: -6-

- Price Point
- Game Number

System Operation: -7-

- Unit Activation
- Unit Deactivation
- Error Mode

Getting a Report Printout:

- Original -8-
- Reprints -8-
- Printout Description -9-

Troubleshooting -10-

Printer Firmware Check and Upgrade -11-

How to Use:

- Employee Instructions -12-
- Money Dropping Procedures -13-
- Cash Office Procedures -14-

DESCRIPTION

BOB'S SPACE RACERS' OPERATOR ACCOUNTING SYSTEM (BSR-OAS) OVERVIEW

Thank you for purchasing a BSR-OAS. The BSR-OAS is an advanced accounting system that our developers took measures to ensure is easy to operate. The BSR-OAS keeps track of individual operators regardless of how many different types of games he/she may work. This ensures the money in the operator's apron will always match the amount of money recorded on the I-button – the heart of the BSR-OAS.

An I-button is a durable memory device, which transfers information quickly and easily. It tracks the operator and the games that operator tended. This makes it almost impossible for someone to steal from the game(s). The operator always has only the one apron and one I-button (during his/her shift), but can work unlimited games while using this system. Each I-button has a unique serial number that is programmed into its memory, which is what makes it possible to track individual operators as they move from game to game. There is no need to collect an operator's money or get a printout every time she/he leaves a game.

The information on an operator I-button can be printed at any time, showing what games the operator worked, what times they worked, how much money they made, etc. Data no longer needs to be collected from the individual games. All of the information needed will be recorded in the operator's I-button and brought to the cash control area by each operator at the end of his/her shift. By keeping track of the operator, you are keeping track of the money. Working hand in hand with the BSR-OAS, your organization can now audit all aspects of the money collecting process. Game owners and loss prevention are given a check against operators and cash control personnel.

There are various ways to collect the money. The operator can count the money, print the report, and drop it all off at the cash control area using the I-button. Or she/he can bring the I-button and money to the cash control area, where it will be counted and sorted by another individual. Any method which suits your location and/or cash handling procedures may also be used. Since the operator's printout does not need to be printed at the same time as the individual game printouts, cash control personnel do not need to have the totals of each game, only the total earnings of each operator. The game earnings and operator earnings can then be compared by a higher level of management to see if everything balances.

The BSR-OAS uses I-button Modules, which read operator I-buttons (blue). The I-button Modules, also, activate the game units much like a traditional kick switch – but *they are used along with the kick switches*, not instead of the kick switches. The I-button is used to activate a game unit by touching it to an I-button Module. (See pictures on next page) A special master I-button (red) is used to program the Game Number and Price Point for each game. Game numbers can be programmed to match existing game locations.

I-Button



The head of the I-button is actually about the size of a nickel.

I-Button Module

Indicator

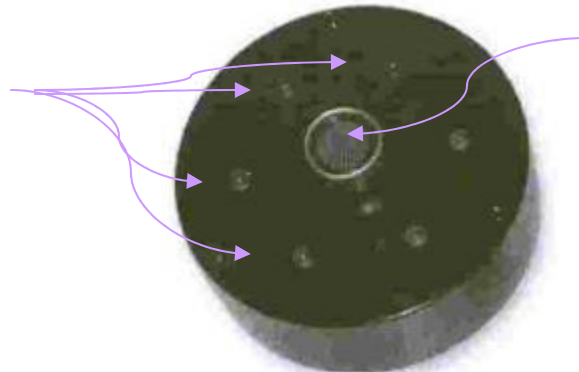

The I-Button clicks onto

Each I-button Module has six indicator lights, which show the status of the game unit. These modules are mounted in front of each game unit, and easily accessible to the game operator. Only when an operator touches their I-button to this module will the game unit be activated.

When the BSR-OAS is first installed, three lights may flash on the I-button Modules, this is because it needs to be set-up. Please follow the steps on the next few pages in order to get your BSR-OAS working for you.

**BEFORE USING
YOU MUST –**

SET-UP

The Printer

A master I-button (red) is needed to get into the printers set up menu. Hold a master I-button to the printer probe and the set up menu will appear as follows:

```

      - SETUP MENU -
    NEXT             EXIT
  
```

Press the “*NEXT*” button to scroll through the menu options. To exit the set up menu, press “*EXIT*”. To get back to this screen, cycle through the set up menu options by depressing “*NEXT*” until this screen appears again.

The Time and Date

While in the set up menu press “*NEXT*” until you arrive at the following:

```

    DATE/TIME
    NEXT      SET
  
```

Press “*SET*” and the time and date will appear. Use the left button to choose what you want to change. Use the right button to increment the underlined selection.

NOTE: The time and date is stored in each individual operator I-button. Changes will not take effect in the I-button until it is held to the printer.

The Number of Copies

This sets the number of copies that will be printed for each new print-out, this allows you to customize the system to your cash control procedures.

While in the set up menu press “*NEXT*” until you arrive at the following:

```

    COPIES =    1
    NEXT       INC
  
```

Press “*INC*” until the desired number of copies you want printed is selected.

The Auto-Logout

This option allows you to automatically create a new block on the printout if the I-button has been idle for a set amount of time. We recommend setting the Auto-Logout time to the length of an operator's break, this way the system will automatically start a new block on the printout once their break is over. Setting this option will ensure you know when an operator's I-button is not used for longer than the set amount of time. While in the set up menu press “*NEXT*” until you arrive at the following:

```

    AUTOLOGOUT = OFF
    NEXT       INC
  
```

Press “*INC*” until the desired amount of minutes for the Auto-Logout is selected.

SET-UP

The Auto-Logout

NOTE: The Auto-Logout setting is stored in each individual operator I-button. Changes will not take effect in the I-button until it is held to the printer.

The Game

The Game Number and Price Point of each game are set using a Master I-button. These options are programmed into the Master I-button using the printer's set up menu.

NOTE: When a Master I-button is held up to the printer probe, the Price Point and Game Number currently stored on that I-button will be cleared.

The Price Point

While in the set up menu, press "*NEXT*" until you arrive at the following:

<i>GAME \$ =</i>	<i>SAME</i>
<i>NEXT</i>	<i>INC</i>

Press "*INC*" until the desired price point is selected. When you have the desired price point press "*SET*", and the following message will appear:

*HOLD I-button
TO PROBE*

When this message appears hold the master I-button to the probe.

NOTE: If a Master I-button is not held to the probe within 10 seconds you will be exited from the set up menu. After you have touched the I-button to the probe and the display returns to the set up menu, programming is complete, this process is very fast. Multiple games can now be programmed at this price point without affecting their game numbers, **as long as the Game Number in the I-button has not been set.** If you also want to change the Game Number do not exit the set up menu, refer to Set up the Game Number. Now that the price is programmed into the Master I-button, refer to Programming the Price Point and the Game Number.

SET-UP

The Game Number

While in the set up menu press “NEXT” until you arrive at the following:

<i>GAME # =</i>	<i>SAME</i>
<i>NEXT</i>	<i>INC</i>

Press “INC” until the desired game number is selected. Holding down “INC” will increment the number in tens. Any number between 1 and 254 can be selected. When you have the desired game number press “SET” and the following message will appear:

*HOLD I-button
TO PROBE*

When this message appears hold the Master I-button to the probe.

NOTE: If a Master I-button is not held to the probe within 10 seconds you will be exited from the set up menu. After you have touched the I-button to the probe and the display returns to the set up menu, programming is complete, this process is very fast. If you also want to change the Price Point, do so before exiting the set up menu. Any game you touch with this master I-button will be set to this Game Number. Only use it on the game it has been programmed for. Now that the game number is programmed into the master I-button, refer to Programming Price Point and Game Number.

PROGRAMMING

The Price Point and the Game Number

Once the master I-button is programmed to the desired Price Point and/or Game Number, the actual game itself has to be programmed. This is done as follows:

Hold the Master I-button to the I-button Module until all of the lights turn on. When this happens you can take the I-button away from the module. Do this to every module in the game, **it is very important that you program every module in the game**. When every module in the game has been programmed, turn the power to the modules off for a few seconds. When the modules turn back on, the changes will have been made.

SYSTEM OPERATION

Unit Activation

To activate a player unit, touch the I-button to the unit's module. Two lights will rotate, indicating the unit is on.

Unit Deactivation

To deactivate a unit, hold the I-button to the module for two (2) seconds. When the lights turn off the unit has been deactivated and the I-button can be removed.

NOTE: Only the I-button that activated the unit can deactivate the unit.

Error Mode

If the lights on the unit flash in a triangle configuration there is an error. This is the result of removing the I-button early, while activating or deactivating a unit. To correct the error, simply hold the SAME I-button to the unit until the lights turn off.

GETTING A REPORT PRINTOUT

Originals

To print the information stored on an operator's I-button, hold the I-button to the printer probe. The display will show "*DOWNLOADING...*" and will automatically start printing when all of the information from the I-button has been downloaded. When the screen says "*PRINTING...*" the I-button can be removed from the probe.

Reprints

To reprint reports hold the I-button to the printer probe, and the screen will show "*DOWNLOADING...*", and then the following menu will appear:

```
REPRINT ?  
NO          YES
```

The I-button can be removed from the probe when this menu appears. Press "*YES*" and the most recent printout will be reprinted. When the reprint is complete the following menu may appear:

```
REPRINT    NEXT?  
NO         YES
```

You can choose to reprint up to 31 blocks starting from the most recent.

TROUBLESHOOTING: BSR-OAS

PROBLEMS/CAUSES

THE GAME

Lights on the unit flash in a triangle configuration.

Unit activates for a few seconds, and then goes into error mode.

Unit will not deactivate.

The unit takes a long time to turn on.

THE PRINTER

Display shows "PRINTING..." but nothing is being printed.

Display is too dark or too light.

SUGGESTED FIX

The 'I-button' was removed too soon while activating or deactivating a unit. Touch the I-button to the unit until the lights turn off. Make sure the same I-button that caused the error is used.

This problem is the same as a "kick switch" that will not stay activated, and should be dealt with in the same manner. This is usually caused by a switch that is stuck (i.e. trigger switch, home switch).

This is caused when an I-button, other than the one which turned on the unit is used to deactivate the unit. Use the same I-button that activated the unit.

The probe on module or I-button itself may be dirty. Use rubbing alcohol or contact cleaner to clean both the I-button and the probe. Make sure you clean both the face and the sides thoroughly. The probe on the printer should also be cleaned in a similar manner periodically.

Make sure printer is on and has paper. Make sure all connections are secure.

Remove the four (4) screws on the front panel, which houses the display. Look on the back of the circuit board. Using a small flat head screwdriver adjust the contrast dial to the desired setting.

PRINTER FIRMWARE CHECK AND UPGRADE

If you already have a BSR Operator Accounting System printer, you must make certain it has the latest firmware. Unplug the printer and wait five (5) seconds, plug the printer back in while watching the LCD screen. The printer will display its firmware version (ex: BSR OAS v1.4). If your printer's firmware version is less than 1.4, you will have to upgrade it using the appropriate yellow I-button. If you did not receive the yellow I-button with your installation kit, please contact us so we can send you one. If you have more than one printer, be certain to check each of them for the most current firmware version as well.

To Upgrade Printer Firmware:

1. Hold the yellow firmware I-button up to the printer's probe. The print's LCD should show...

UPDATE FIRMWARE?
NO YES

2. Pressing "Yes" will bring you to the next screen...

DOWNLOADING

3. Keep holding the I-button to the probe until the screen shows...

DOWNLOADING...
NEXT

4. Press "Next" to complete the firmware update.

LCD SCREEN

YELLOW FIRMWARE I-button

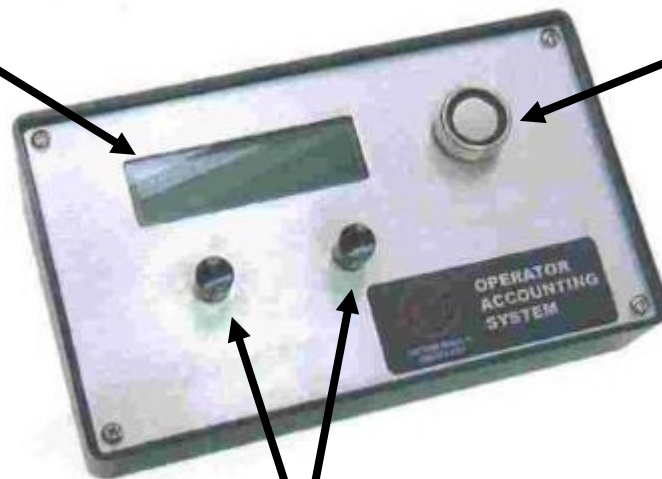

RESPONSE BUTTONS

HOW TO USE:

EMPLOYEE INSTRUCTIONS FOR GAMES USING THE BSR-OAS I-BUTTON SYSTEM

Wearing the I-button

The 'I-button' should be wrapped around the wrist or clipped to your belt loop.

Using the I-button

1. Your 'I-button' is used to activate the individual game units (turn player on) in a group game. After you take the money from a customer, you should immediately use your I-button to activate the unit they are standing/sitting at.
2. The 'I-button' activates the player unit by touching both the side and the top of the module. The quickest and easiest way to use the I-button is to slide it in at an angle. This assures that the side and the top is touched. **DO NOT PUSH HARD** when using the I-buttons!
3. You must leave the I-button on the module until the red lights flash in a circular motion. This indicates that the player unit is activated.
4. To deactivate a player unit, the same I-button that activated it *must be placed back on the module and held there until the unit is turned off* do not remove the I-button until the module is deactivated. (All lights will turn OFF.)
5. If the I-button is pulled away from the module too fast, an error will occur. The module will show an error by having the three lights flash in a random pattern on it. If this happens the same operator who activated the module must go back and hold their I-button to the module. This will clear the error and activate the unit. (The unit will not activate if error lights are flashing).
6. **EMPLOYEES ARE ACCOUNTABLE AND RESPONSIBLE FOR ALL MONEY RECEIPTS USING I-BUTTONS.** DO NOT LET ANYONE HAVE ACCESS TO OR USE YOUR 'I-BUTTON'.

MONEY DROPPING PROCEDURES FOR GAMES USING THE BSR-OAS I-BUTTON SYSTEM

Before an Operator leaves a game using a BSR-OAS I-button system, they must drop the money they have made with that game in a drop-box.

This is done by the following steps:

1. Take all the money out of your apron – make certain you check all of the pockets.
2. Count out your original starting bank and place it back in the apron.
3. Fill out a Drop Slip with your name, time, date, game number, and badge number.
4. Place all the remaining money and the Drop Slip in the sealable Tamper Proof Bag (TPB).
5. Rip the top numbered receipt off top of TP13 and keep it to be turned in at the end of the night with your I-button.
6. Seal the bag and print your name, game number, and game name on the outside of the bag.
7. Drop the bag in the drop-box at the game.
8. You are now ready to take your apron with your starting bank inside and leave the game.
9. When you turn in your starting bank at the end of the day, you also need to turn in your I-button and bag receipts.

*** DO NOT LET ANYONE HAVE ACCESS TO, OR USE OF,
YOUR I-BUTTON MACHINE! ***

CASH OFFICE PROCEDURES FOR GAMES USING THE BSR-OAS I-BUTTON SYSTEM

1. At the beginning of each day each Game Operator is issued an I-button with their starting bank.
2. At the end of their shift, or when they turn in their starting bank, the Game Operator must also turn in their I-button.
3. The Cash Office Employee is to immediately print 2 copies of the Game Operator's I-button report (one for the Cash Office and one for Cash Control).
4. The Game Operator must then print their name, badge ID and also sign both of the I-button printouts.
5. The Cash Office Employee records bag tag receipt numbers on the duplicate I-button printout.
6. The Cash Office Employee then staples the operators bag tags to the I-button report and drops it in the drop-box to cash control.
7. If there is a discrepancy the following day with the dollar amount on the game meters and the dollar amount reported by Cash Control for an I-button Game, then the I-button reports can be used to find the discrepancy.

REMOTE START

PROGRAMMING THE REMOTE START

1. LOCATE the Receiver Learn Code Button. (Figure 1)
2. PRESS and RELEASE the Learn Code Button and the Radio Signal Indicator will blink.
3. PRESS the remote control button once and the Radio Signal Indicator will light continuously.
4. PRESS the remote control button again and the Radio Signal Indicator will go out.
1. Note: You must perform Steps 2 and 3 within 30 seconds. If the Radio Signal Indicator begins to blink rapidly (about 4 times per second) -you must repeat Steps 2 and 3.
2. Note: If the Radio Signal Indicator does not respond correctly during any part of the programming processes, check wiring from Receiver to transformer.
5. TEST the remote control by pressing the remote control button once to start the garage door opener and a second time to stop the garage door opener.
3. Note: If garage door opener does not work, check wiring from Receiver to garage door opener.
4. You must perform Steps 2 through 4 for each remote control, wireless keypad or other access device. The Intellicode Universal Receiver can be programmed to accept a maximum of 7 Intellicode remote controls, wireless keypad or other access devices at a time.
5. REPLACE receiver cover.

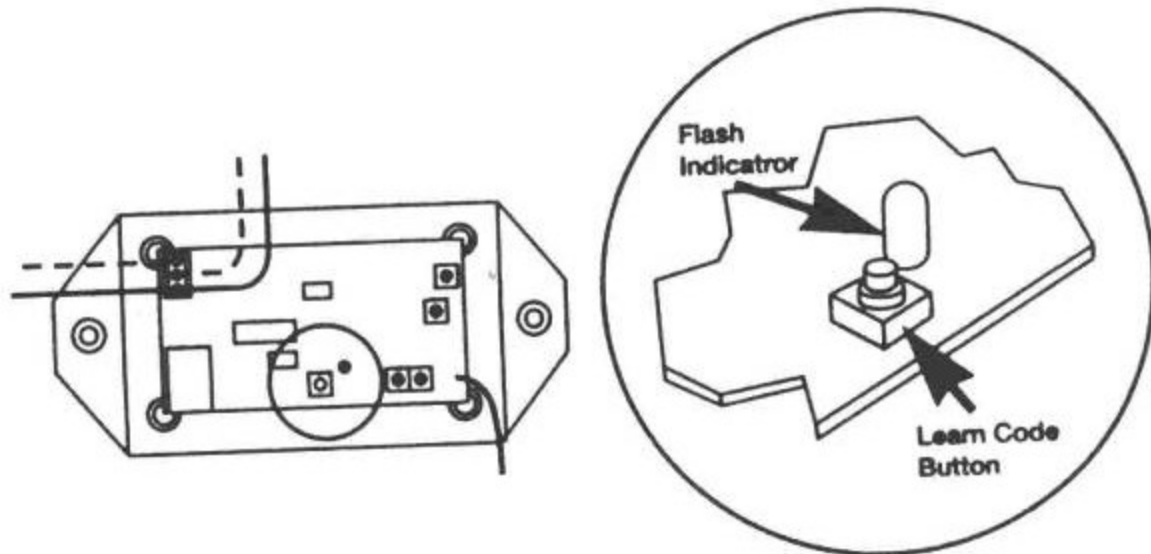

Figure 1

REPLACING THE BATTERY

1. Battery replacement (your Remote Control is battery powered).
2. Gently PUSH straight IN on Tab as shown.
3. Use ball point pen, coin or small screwdriver.
4. Battery cover snaps open.
5. INSTALL new battery in same position, use EVEREADY. A23, 12 Volt (lighter type).
6. PRESS on battery cover until it snaps closed.

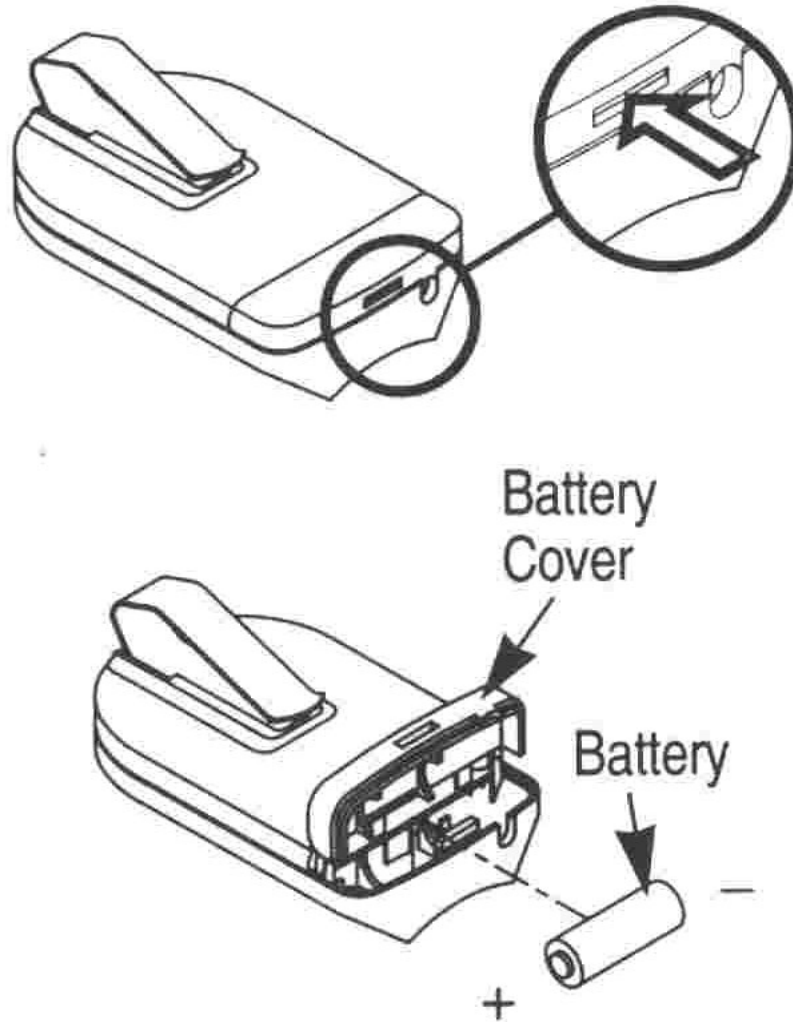
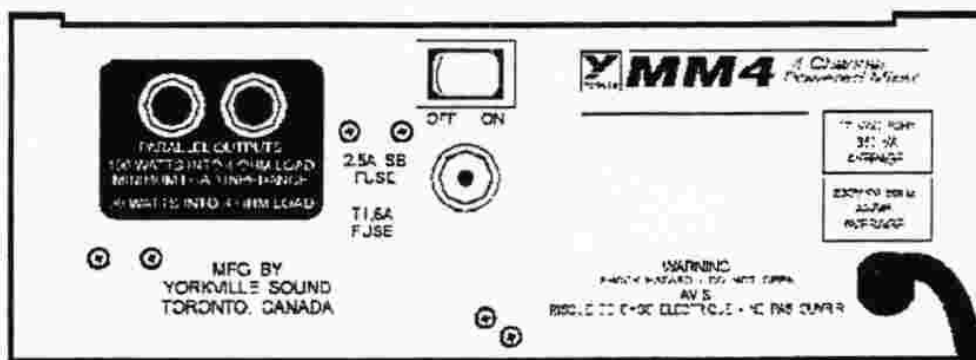

Figure 2



MM-4

FOUR CHANNEL POWERED MIXER



SPECIFICATIONS

Power Output:	140 Watts RMS @ 4-Ohms 90 Watts RMS @ 8-Ohms
Harmonic Distortion:	< 1.0% at Full Power
Input Sensitivity:	1.0 Volt RMS
Output Load:	4-Ohm minimum
Power Requirements: (In Europe)	117 VAC 60 Hz 360 VA 220 VAC 50 Hz 360 VA

CAUTION: DO NOT REMOVE COVER (OR BACK). NO USER SERVICEABLE PARTS INSIDE.

REFER SERVICING TO QUALIFIED SERVICE PERSONNEL.

Read Instructions:

The Owner's Manual should be read and understood before operation of your unit. Please, save these instructions for future reference.

Packaging:

Keep the box and packaging materials, in case the unit needs to be returned for service.

WARNING:

When using electric products, basic precautions should always be followed, including the following:

Power Sources:

Your unit should be connected to a power source only of the voltage specified in the owners manual or as marked on the unit. This unit has a polarized plug. Do not use with an extension cord or receptacle unless all three blades can be fully inserted to prevent blade exposure. Precautions should be taken so that the grounding scheme on the unit is not defeated.

Power Cord:

The AC supply cord should be routed so that it is unlikely that it will be damaged. If the AC supply cord is damaged DO NOT OPERATE THE UNIT.

Service:

The unit should be serviced only by qualified service personnel.

INTRODUCTION

Your new Micromix model MM-4 is the latest addition to our growing Micromix line of powered mixers. We at Yorkville Sound are confident that you will find your new MM-4 to be an efficient and versatile solution to your sound reinforcement needs. This manual contains information to help you get the maximum performance from your Micromix. We hope you will take the time to read it over.

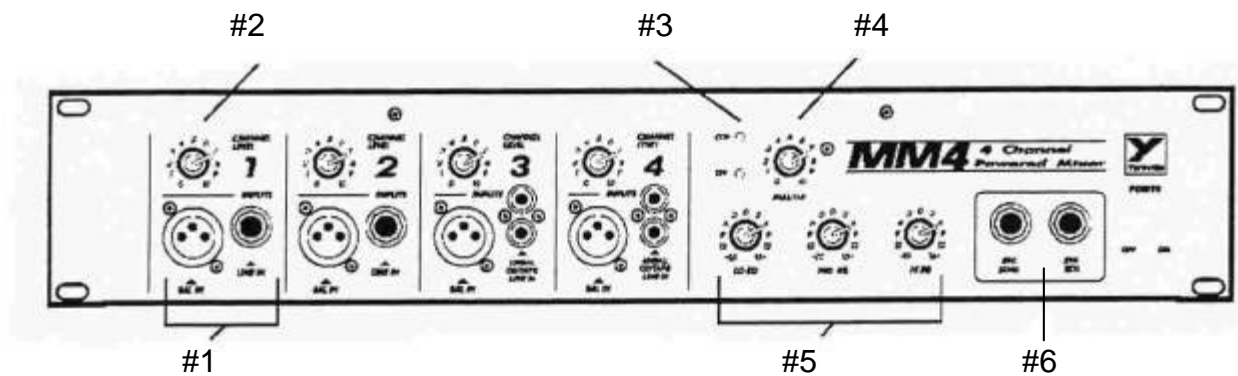

MICROPHONE AND LINE INPUTS - #1

The MM-4 features both balanced microphone and unbalanced line inputs on channels 1 through 3. The standard XLR type microphone inputs are electronically balanced for maximum noise suppression. The input characteristics match those of professional low impedance dynamic microphones such as the Shure SM-58 and the Image IM-400.

The LINE inputs are standard 1/4" phone jacks which accept single-ended signals from guitars, synthesizers, electric pianos, tape recorders, unbalance high-impedance microphones, and the like.

Do not connect signals to both types of inputs on any one channel. Use either the unbalanced or the balanced input on any one channel, but not both. Connecting to both inputs on one channel will cause improper operation of the input circuit.

Channel 4 is a special channel, in which the LINE input (1/4" phone jack) has been replaced by two RCA jacks. The XLR balanced input functions identically to the other XLR inputs, but the RCA inputs are specifically intended to receive stereo signals from compact disk players or tape players. Within the MM-4, these stereo signals are electronically summoned to a monophonic signal.

CHANNEL LEVEL CONTROLS - #2

Each channel has a separate level control. Advancing this control increases the contribution of the associated channel's signal to the overall mix.

CLIP LED - #3

The Clip LED is located next to the master control. It will light when any signal anywhere within the mixer section gets to within 3dB of clipping. Under normal use, it is expected that this LED will flash for brief instants during the loudest musical peaks, if the LED is off, you can be sure that the mixer section of the MM-4 is not clipping.

The LED circuitry is intended to indicate clipping *only* in the mixer section of the MM-4. It is not implemented as an indicator of clipping in the power-amp section. Remember also that the Clip Led can't indicate clipping in any external amplifier connected to the MM-4.

MASTER CONTROL - #4

The signals from the four channels are internally routed to the Master section, where they are combined into a monophonic signal. This signal is then routed to the EQ and then to the power amplifier within the MM-4. The Master control varies the level of this combined signal. The signal level sent to the EFFECTS LOOP SEND jack is also governed by the Master Control.

EQ SECTION - #5

The tone controls provided by the MM-4 consist of a three band active shelving equalizer. The signal arriving from the Master Control passes through this on its way to the power amplifier. Within the EQ section, the signal is temporarily split into three components. The lowest frequency (bass) components may be adjusted with the LO control, the middle (midrange) frequencies are varied by the MID control, and the HI control adjusts the high (treble) frequencies.

The numbers around the LO, MID, and HI dials indicate the amount of boost at cut applied to the signal, in the decibels. The center or "0" positions correspond to a "flat" response where the signal level remains unchanged as it passes through the EQ. Rotating the LO control clockwise from this position will increase the BASS frequency components, while a counter-clockwise rotation will decrease the BASS sounds.

When adjusting the EQ controls, it is best to begin by setting all three controls to their center "0" positions. From there you can experiment until you get the sound you like.

EFFECTS LOOP - #6

An external effect such as a digital delay, echo, phaser, flanger, or parametric equalizer can be easily interfaced to the MM-4. Any effect device designed to operate at the 0dB line levels will properly interface to your MM-4. As a rule, any device which is not foot operated will work just fine; "foot pedal" devices which are designed to accept a guitar directly can often be overloaded by standard line level signals.

Connect the input of the effect device to the SEND jack of the MM-4 EFFECTS LOOP. Connect the output of the effect device to the RTN jack of the MM-4 EFFECTS LOOP. Now the MM-4's signal is routed through the effect device on its way to the MM-4's power amplifier.

The EFFECTS LOOP SEND jack may also be used as a line output jack. You can augment the MM-4's internal amplifier by connecting an external power amplifier's input to this jack.

Plugging into the EFFECTS LOOP RTN (Return) jack will disconnect the MM-4's direct internal signal path from the MM-4's power amplifier and substitute the signal present at the RTN jack. This means that you can use the EFFECTS LOOP to send the signal from the MM-4's mixer to an external power amplifier while using the MM-4's built-in power amplifier for some other purpose.

POWER AMPLIFIER - #7 (inside)

The MM-4 power amplifier delivers approximately 150 watts into a 4-Ohm load. There are two speaker output jacks on the rear panel of the MM-4. You may connect an 8-Ohm speaker to each jack, or you may connect one 4-Ohm speaker.

The MM-4's power amplifier is fully protected from all abnormal load conditions. Shorting the outputs of the MM-4 will not harm the unit. The power amplifier will "shut down" if it senses an improper load condition. Such a condition can result from connecting too many speakers, (too low a load-impedance), to the MM-4. In this case, the sound will be intermittent as the power amplifier repeatedly tests the load to determine if it can resume operation. The solution is to reduce the number of speakers you have connected.

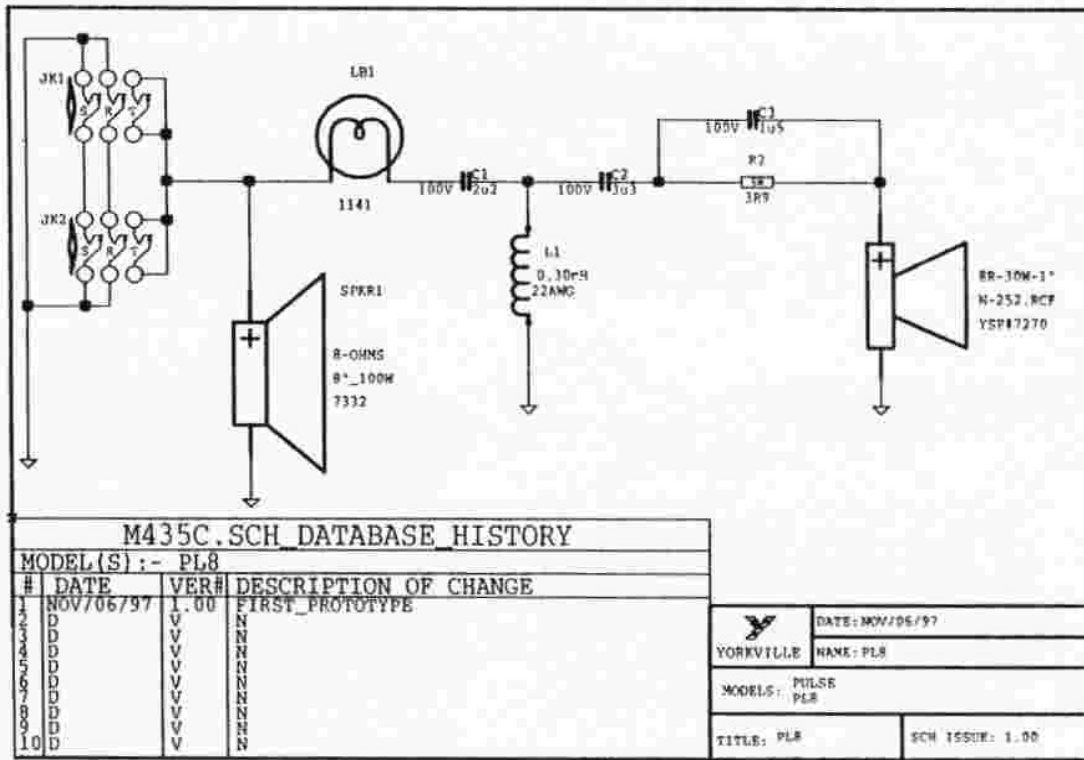

ASSEMBLY M435-4.00
PCB MECH M435-4.00

M435.PCB_DATABASE_HISTORY

#	DATE	VER#	DESCRIPTION OF CHANGE
1	JAN/28/97	1.00	FIRST PROTOTYPE
2	JUN/12/97	2.00	ADD R2
3	OCT/15/97	3.00	REMOVE FOR C8/C12
4	DEC/08/97	4.00	REMOVE FOR 3 UP SPREAD FOR TABS
5			TABS ADDED FOR PL1070V
6			
7			
8			
9			
10			

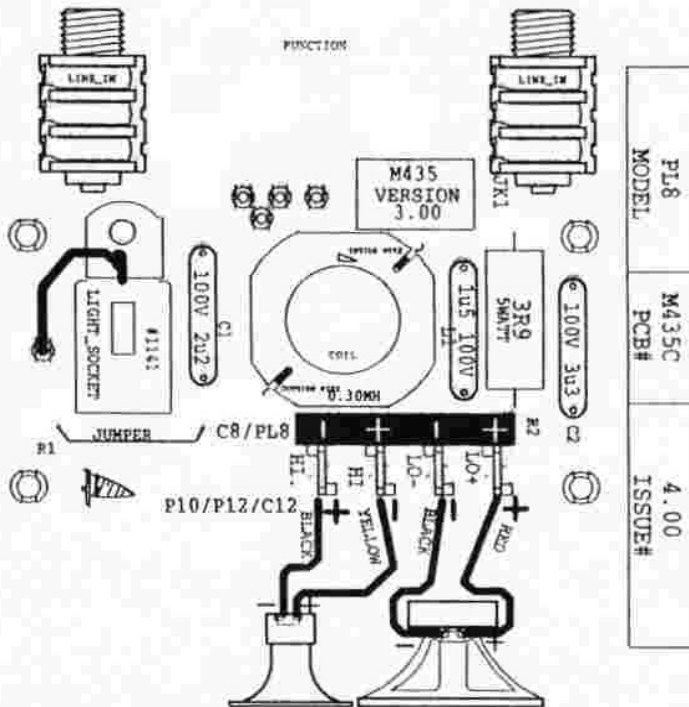

PRO STAR by TELEX[®]

OPERATING MANUAL

UHF WIRELESS MICROPHONE SYSTEM

SPECIFICATIONS

U1311 2, UH1 2, UGB11 2 **TRANSMITTER:**

RF Power Output	10 to 15 mW typical
Battery	9.OVDC Alkaline
Battery Life	8 to 12 hours typical

FCC

Type Accepted to FCC
Part 74H

UR12, UGR12 **RECEIVER:**

RF Sensitivity SINAD	Less than 0.8 uV for 12 dB
Diversity	Full True Diversity
Audio Output Level, 1/4" in. jack	0.775V RMS/1 00k load
Audio Output Level, XLR jack	20 dBV, 600 Ohm load
Audio Frequency Response	20 Hz to 15KHz \pm 2dB
Audio Frequency Distortion	Less than 0.5%

POWER

12 VDC from supplied wall transformer 12 VDC from external battery or filtered power supply.

Part	15 Notifications
------	------------------

FCC REGULATIONS

The Telex Models UB12, UGB12, and UH12 are Type Accepted under United States Federal Communications Commission Part 74H. The UR1 2 and UGR1 2 Receivers are accepted under the Part 15 Notification Procedure of the Federal Communications, Commission. Licensing of Telex equipment is the user's responsibility and license ability depends upon the user's classification, and frequency selected. Telex urges the user to contact the appropriate telecommunications authority before ordering and choosing frequencies.

CAUTION: Changes or modifications made by the user could void the user's authority to operate the equipment.

Receiver Set-Up

Place the receiver in a location that is in direct line of sight to the transmitter. Unfold the antennas. Set them in a "rabbit ears" position as shown in the illustration. Plug the power supply into any convenient outlet. Plug the cable end of the supply into the power jack and route the cord through the retainer to prevent pull out. The "Diversity" light should come on at this time.

Connect an audio cable to either the 1/4 inch jack on the front or to the balanced output on the rear of the receiver. Connect the other end to your audio equipment. Set the output level control on the front of the receiver to the "12 o'clock" position if you are using the 1/4 inch jack.

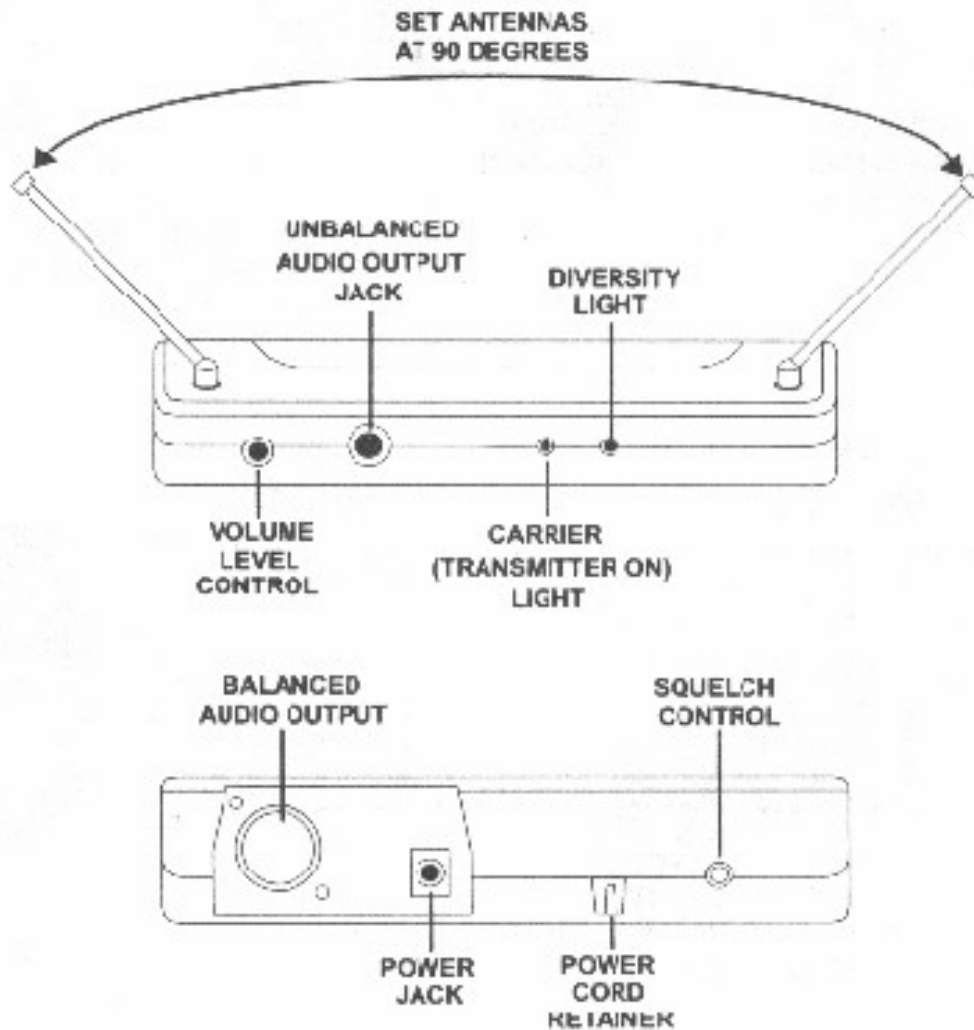

Diversity Light

The diversity light is a bi-color LED (orange/green) that is illuminated any time the receiver has power. When it changes color this indicates that the diversity circuit is activated to optimize reception.

Belt Pack Set-Up

Open the battery door and install a fresh 9 volt alkaline battery. Plug in your microphone. Clip or place the transmitter and microphone where desired and turn on the power switch. The battery light should flash once and go out. The "CARRIER" light at the receiver should be on at this time. Turn on the "AUDIO" switch. You are now ready to use the microphone.

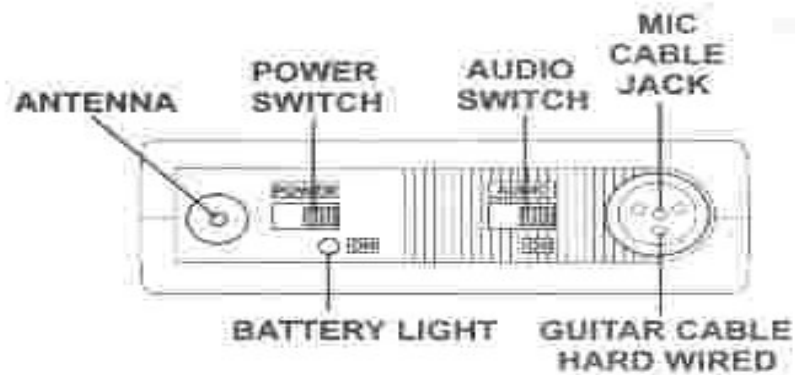
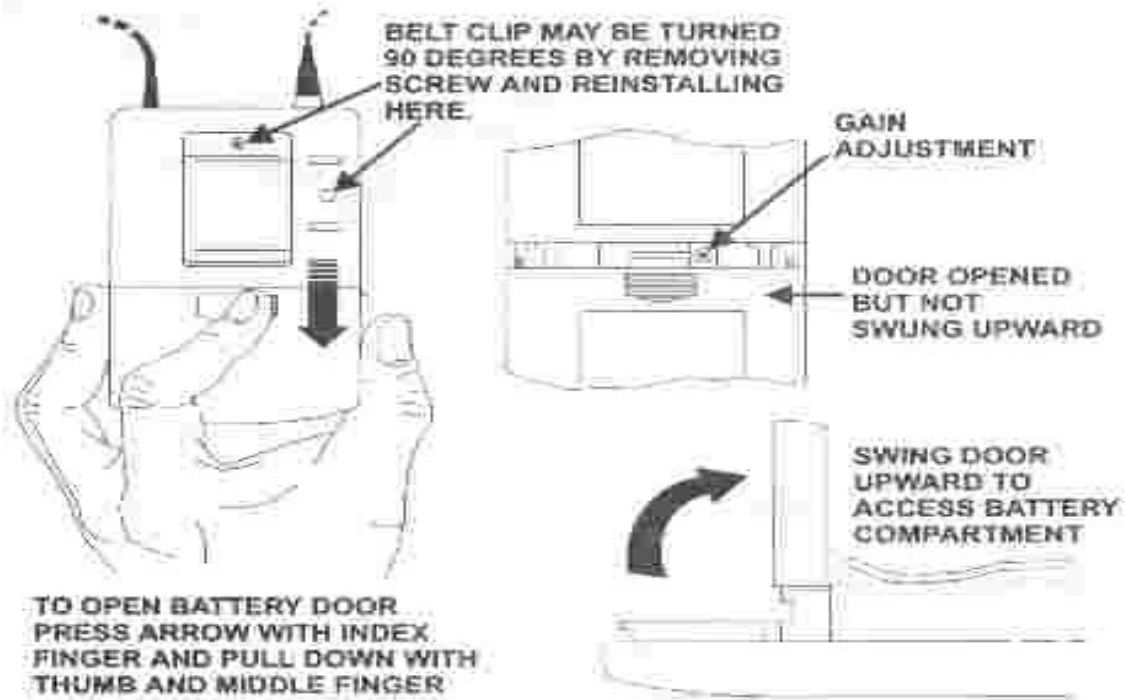

Model PH-21 Microphone

General Description

The Telex Model PH-21 Head worn Microphone consists of a microphone assembly mounted on the pivot arm of an adjustable headband. This high-quality, lightweight headset is specifically designed to provide excellent performance as a vocal microphone for drummers and keyboard players. This is also designed for use in special event remote broadcasting, auctions and other hands free broadcast applications.

The microphone assembly is attached by a spring clip to a pivot arm which rotates 360 degrees allowing the boom microphone to be properly positioned. The spring clip also allows the assembly to be worn with a variety of eyeglasses. An adjustable, field-replaceable clothing clip removes the cord weight from the head of the user for long-term comfort.

Microphone

The miniature close-talking Electret microphone element is boom-mounted in a high-impact-resistant plastic housing. The boom can be swiveled over 180 degrees side-to-side to allow for precise positioning of the microphone. A foam windscreen is supplied with each microphone.

Headband

The split piece headband consists of two stainless steel springs sheathed in black nylon webbing. The two stainless steel springs are adjustable to 180 degrees. Head pads are connected to the headband by stainless steel sliders that permit over two inches (50 mm) of adjustment. The headband should be placed over the crown of the user's head for stable operation. The head pad cushions are adhesive-back polyester urethane foam and are field-replaceable.



Model PH-21

The Model PH-21 is terminated with a TA4F 4-pin plug that allows the microphone to be interfaced with the Telex PS10 Power Module and the Telex WT-50 Wireless Transmitter (see wiring diagram).

Specifications

- Element: Electret. Close-talking
- Frequency Response: 20 to 20,000 Hz
- Impedance: 3,000 Ohms
- Output Level at 1 kHz: -60 dB (0 dB = 1 V/ %bar)
- Maximum Sound Pressure: 130 dB
- Supply Voltage: + 1.5 to 20 Vdc at pin 3 of headset connector Cord: 3 ft (0.9 m)
- Microphone Plug: TA4F Weight: 8 oz (227 grams)
- Color: Black

Model PH-21 Head-Worn Microphone	64327-001
Replacement Windscreen	59747-001
Replacement Spring Clip	52878-000
Replacement Clothing Clip	63097-002
Replacement Head Cushions	63575-000
Replacement Carrying Pouch	57893-000

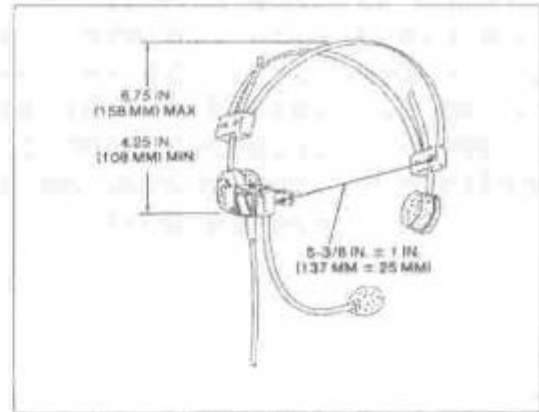
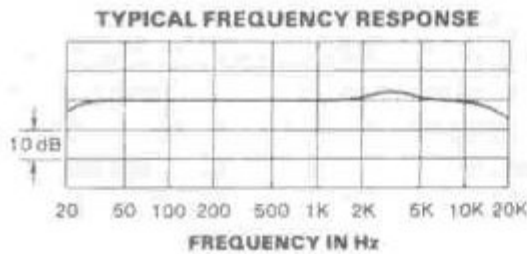

Dimension Drawing

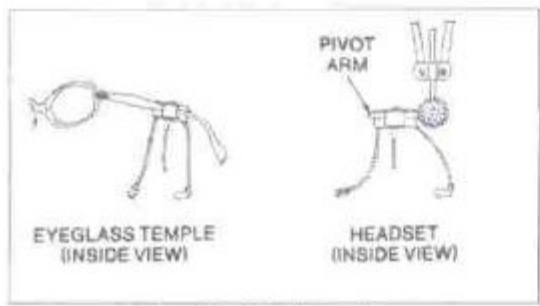

Mounting Configurations

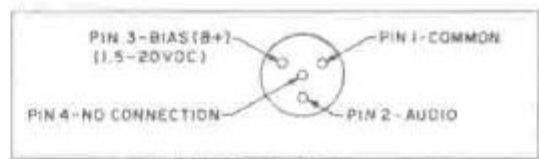

PH-21 Wiring Diagram

System Set-Up

Talk or sing into the microphone at your normal volume and monitor the sound system. If the sound is distorted, try turning down the audio amplifier input control. You may also need to turn down the output level on the front of the receiver (if you are using the 1/4" jack) and/or the "GAIN" control on the transmitter.

If the sound is low or weak, you may have to increase one or more of the controls. The squelch control on the back of the receiver may be adjusted to increase range or reduce interference. Turn the control counter-clockwise to increase range.

CAUTION! DOING SO WILL MAKE YOUR SYSTEM MORE SUSCEPTIBLE TO OUTSIDE INTERFERENCE!

Turn the control clockwise to reduce interference from noise and outside radio signals. It is usually best to set the squelch with the transmitter turned off. Turn the control counter-clockwise until you hear noise or interference over your sound system. Then turn it clockwise until the noise is squelched off. This setting will give you your best interference free range.

Battery and Battery Light

Use fresh 9 volt alkaline batteries from a quality manufacturer (8.4 volt ni-cad batteries may be used but will yield much shorter "on" time). When the power switch is turned on, the battery light will flash one time if the battery is good. If the light does not flash or stays lit continuously, the battery is weak or dead. If the light comes on during use, the battery is weakening and should be replaced as soon as possible.

MAINTENANCE

Daily: Test all equipment prior to the beginning of each shift to be certain that it is in good working order, and visually check all equipment for signs of physical damage at the end of each shift.